

# Lucy Islands Eelgrass Study



June 2011

Research carried out by **Ocean Ecology**

1662 Parmenter Ave.

Prince Rupert, BC V8J 4R3

Telephone: (250) 622-2501

Email: [blueseas@oceanecology.ca](mailto:blueseas@oceanecology.ca)

In partnership with WWF

Funding provided by MEC



# **Lucy Islands Eelgrass Study**

Draft

Prepared for: Mike Ambach  
Program Manager  
World Wildlife Fund - Prince Rupert  
#3-437 3rd Ave. West  
Prince Rupert BC  
V8J 1L6

Prepared by: Ocean Ecology

## Table of Contents

Table of Contents .....	ii
List of Figures .....	iv
List of Tables .....	vii
Executive Summary.....	viii
1 Introduction.....	1
2 Lucy Islands Eelgrass Survey Methodology .....	8
2.1 Overall Project Design .....	8
2.2 Single-Beam Sounder Bathymetric Survey.....	9
2.2.1 Single-Beam Sounder System.....	9
2.2.2 Survey Design.....	9
2.2.3 Depth Grids and Contour Plots.....	11
2.3 Towed Benthic Video Survey.....	11
2.3.1 Towed Video System.....	11
2.3.2 Video Recording System .....	12
2.3.3 Survey Design.....	12
2.4 Classification and Mapping .....	16
2.4.1 Database of Species and Substrate Classifications .....	16
2.4.2 ArcGIS Mapping.....	16
2.4.3 Substrate Maps.....	17
2.4.4 Range Maps.....	17
2.4.5 Eelgrass Maps .....	17
2.4.6 Diversity Analysis Using Range Maps .....	18
2.4.7 Species Richness Maps.....	18
2.5 High Definition Drop Camera Survey.....	19
2.5.1 Drop Camera System .....	19
2.5.2 Survey Design.....	20
2.5.3 Photograph Analysis .....	20
2.6 Side Scan Sonar Survey.....	22
2.6.1 Side Scan Sonar System.....	22
2.6.2 Survey Design.....	23
2.6.3 Viewing of Raw Side Scan Sonar Data .....	23
2.6.4 Simple Georeferencing and Mosaicing of the Side Scan Sonar Data.....	23
2.6.5 Calculation of Eelgrass Cover Using Grey Level Co-occurrence Matrices (GLCM).....	24
2.6.6 Processing of Side Scan Sonar Data .....	25
2.6.7 Bottom Hardness .....	25
2.6.8 Calculation of Eelgrass Height.....	25
2.6.9 Macrophyte Height Profiles.....	26
2.6.10 Observations of Anthropogenic Disturbances in the Eelgrass Bed .....	26
2.7 Multibeam Sonar Survey.....	28
2.7.1 Multibeam Sonar System.....	28
2.7.2 Survey Design.....	28
2.7.3 Processing of Multibeam Sonar Data .....	28
2.8 Beach Seining.....	30
2.8.1 Survey Design.....	30
2.8.2 Organism Identification .....	30
2.9 Bird Observations.....	31
2.10 Observations of Human Activities .....	31
3 Lucy Islands Eelgrass Study Results and Discussion .....	32
3.1 Eelgrass Observations in the Upper Intertidal Zone .....	32
3.2 Single-beam Sonar Bathymetric Survey .....	35
3.2.1 Bathymetry.....	35
3.3 Benthic Video Survey.....	37
3.3.1 Substrate.....	37

3.3.2	Flora .....	42
3.3.3	Fauna .....	54
3.3.4	Diversity .....	59
3.4	High Definition Drop Camera Survey .....	64
3.5	Side Scan Sonar Survey .....	68
3.5.1	Raw Side Scan Sonar Data .....	68
3.5.2	Simple Georeferencing and Mosaicing of the Side Scan Sonar Data .....	70
3.5.3	Calculation of Eelgrass Cover Using Grey Level Co-occurrence Matrices (GLCM) .....	76
3.5.4	Processing of Side Scan Sonar Data .....	81
3.5.5	Bottom Hardness .....	91
3.5.6	Calculation of Eelgrass Height.....	96
3.5.7	Macrophyte Height Profiles.....	101
3.5.8	Observations of Anthropogenic Disturbances in the Eelgrass Bed .....	104
3.6	Multibeam Sonar Survey .....	108
3.7	Beach Seining .....	110
3.8	Bird Observations.....	112
3.9	Observations of Human Activities .....	114
3.10	Feasibility Study for Placement of Fixed Anchors .....	114
4	Project Outcomes as Related to Project Objectives .....	124
5	Project Deliverables .....	128
6	References Cited.....	129
7	Appendix.....	132
8	Disclaimer.....	143

## List of Figures

Figure 1. Location of the Lucy Islands relative to the Skeena River estuary. ....	3
Figure 2. Shoreline biophysical classification for Lucy Islands showing location of surfgrass. ....	4
Figure 3. Location and boundaries of the Lucy Islands Conservancy. ....	5
Figure 4. Location of the Lucy Islands eelgrass study. ....	7
Figure 5. Single-beam sounder bathymetric survey carried out on July 17 <sup>th</sup> , 2010. ....	10
Figure 6. Towed video camera system about to be deployed. ....	12
Figure 7. Benthic video survey carried out on July 17 <sup>th</sup> , 2010. ....	13
Figure 8. Benthic video survey carried out on October 27 <sup>th</sup> , 2010. ....	14
Figure 9. Benthic video survey carried out on April 20 <sup>th</sup> , 2011. ....	15
Figure 10. High definition drop camera in the lander frame. ....	19
Figure 11. High definition drop camera survey carried out on July 19 <sup>th</sup> , 2010. ....	21
Figure 12. Side scan sonar towfish in towing position. ....	23
Figure 13. Lines used for cross-sectional profiles of macrophyte height at the Lucy Islands study site. ....	27
Figure 14. Multibeam sonar bathymetric survey carried out on July 17 <sup>th</sup> , 2010. ....	29
Figure 15. Perpendicular set deployment and retrieval of a beach seine (Hahn et al., 2008). If the person on the shore at A does not move to I, this becomes a perpendicular quarter-arc set. ....	30
Figure 16. Eelgrass in the upper intertidal zone at Lucy Islands exposed during low tide. ....	32
Figure 17. Exposed surfgrass in the upper intertidal zone at Lucy Islands. ....	33
Figure 18. Flowering head of <i>Zostera marina</i> at the Lucy Islands site. ....	33
Figure 19. Flowering head of <i>Phyllospadix scouleri</i> at the Lucy Islands site. ....	34
Figure 20. 0.5 m bathymetric plot for the Lucy Islands study site. ....	36
Figure 21. Overview of the temporal changes in substrate particle size at the Lucy Islands study site. ....	38
Figure 22. Substrate particle size at the Lucy Islands study site on July 17 <sup>th</sup> , 2010. ....	39
Figure 23. Substrate particle size at the Lucy Islands study site on October 27 <sup>th</sup> , 2010. ....	40
Figure 24. Substrate particle size at the Lucy Islands study site on April 20 <sup>th</sup> , 2011. ....	41
Figure 25. Overview of the temporal changes in eelgrass density at the Lucy Islands study site. ....	46
Figure 26. Density map for eelgrass at the Lucy Islands study site on July 17 <sup>th</sup> , 2010. ....	47
Figure 27. Density map for eelgrass at the Lucy Islands study site on October 27 <sup>th</sup> , 2010. ....	48
Figure 28. Density map for eelgrass at the Lucy Islands study site on April 20 <sup>th</sup> , 2011. ....	49
Figure 29. Overview of the temporal changes in eelgrass cover at the Lucy Islands study site. ....	50
Figure 30. Percentage eelgrass cover at the Lucy Islands study site on July 17 <sup>th</sup> , 2010. ....	51
Figure 31. Percentage eelgrass cover at the Lucy Islands study site on October 27 <sup>th</sup> , 2010. ....	52
Figure 32. Percentage eelgrass cover at the Lucy Islands study site on April 20 <sup>th</sup> , 2011. ....	53
Figure 33. Fauna observations at the Lucy Islands study site on July 17 <sup>th</sup> , 2010. ....	56
Figure 34. Fauna observations at the Lucy Islands study site on October 27 <sup>th</sup> , 2010. ....	57
Figure 35. Fauna observations at the Lucy Islands study site on April 20 <sup>th</sup> , 2011. ....	58
Figure 36. Overview of the temporal changes in species richness at the Lucy Islands study site. ....	60
Figure 37. Species richness at the Lucy Islands study site on July 17 <sup>th</sup> , 2010. ....	61
Figure 38. Species richness at the Lucy Islands study site on October 27 <sup>th</sup> , 2010. ....	62
Figure 39. Species richness at the Lucy Islands study site on April 20 <sup>th</sup> , 2011. ....	63
Figure 40. Image from the high definition drop camera showing a carinate dovesnail. ....	64
Figure 41. Image from the high definition drop camera showing a carinate dovesnail and a small kelp crab. ....	65
Figure 42. Eelgrass cover per quadrat at the Lucy Islands study site on July 17 <sup>th</sup> , 2010. ....	67
Figure 43. An example of raw side scan sonar data as viewed by the HumViewer software. ....	69
Figure 44. An example of a georeferenced side scan sonar image from the Lucy Islands study site on July 18 <sup>th</sup> , 2010. ....	71
Figure 45. Overview of the temporal changes in eelgrass at the Lucy Islands study site as seen by the simple side scan sonar mosaics. ....	72
Figure 46. Side scan mosaic from the Lucy Islands study site on July 18 <sup>th</sup> , 2010. ....	73

Figure 47. Side scan mosaic from the Lucy Islands study site on October 27 <sup>th</sup> , 2010. ....	74
Figure 48. Side scan mosaic from the Lucy Islands study site on April 20 <sup>th</sup> , 2011. ....	75
Figure 49. Overview of the temporal changes in eelgrass cover at the Lucy Islands study site as calculated using GLCM analysis. ....	77
Figure 50. Eelgrass cover based on GLCM analysis at the Lucy Islands study site on July 18 <sup>th</sup> , 2010. ....	78
Figure 51. Eelgrass cover based on GLCM analysis at the Lucy Islands study site on October 27 <sup>th</sup> , 2010. ....	79
Figure 52. Eelgrass cover based on GLCM analysis at the Lucy Islands study site on April 20 <sup>th</sup> , 2011. ....	80
Figure 53. Overview of the temporal changes in eelgrass at the Lucy Islands study site as seen by the MIPS processed side scan sonar. ....	82
Figure 54. MIPS mosaic of side scan data from the Lucy Islands study site on July 18 <sup>th</sup> , 2010. ...	83
Figure 55. MIPS mosaic of side scan data from the Lucy Islands study site on October 27 <sup>th</sup> , 2010. .....	84
Figure 56. MIPS mosaic of side scan data from the Lucy Islands study site on April 20 <sup>th</sup> , 2011. .	85
Figure 57. MB-System mosaic of side scan data from the Lucy Islands study site on July 18 <sup>th</sup> , 2010. ....	86
Figure 58. Overview of the temporal changes in eelgrass at the Lucy Islands study site as seen by MIPS processed side scan sonar with false-coloring. ....	87
Figure 59. False-colored MIPS mosaic of side scan data from the Lucy Islands study site on July 18 <sup>th</sup> , 2010. ....	88
Figure 60. False-colored MIPS mosaic of side scan data from the Lucy Islands study site on October 27 <sup>th</sup> , 2010. ....	89
Figure 61. False-colored MIPS mosaic of side scan data from the Lucy Islands study site on April 20 <sup>th</sup> , 2010. ....	90
Figure 62. Overview of the temporal changes in seafloor hardness at the Lucy Islands study site. .....	92
Figure 63. Seafloor hardness at the Lucy Islands study site on July 18 <sup>th</sup> , 2010. ....	93
Figure 64. Seafloor hardness at the Lucy Islands study site on October 27 <sup>th</sup> , 2010. ....	94
Figure 65. Seafloor hardness at the Lucy Islands study site on April 20 <sup>th</sup> , 2011. ....	95
Figure 66. Overview of the temporal changes in macrophyte height at the Lucy Islands study site. .....	97
Figure 67. Vegetation height at the Lucy Islands study site on July 18 <sup>th</sup> , 2010. ....	98
Figure 68. Vegetation height at the Lucy Islands study site on October 27 <sup>th</sup> , 2010. ....	99
Figure 69. Vegetation height at the Lucy Islands study site on April 20 <sup>th</sup> , 2011. ....	100
Figure 70. EW eelgrass profiles for the Lucy Islands study site. ....	102
Figure 71. NS eelgrass profiles for the Lucy Islands study site. ....	103
Figure 72. Observations of anthropogenic disturbances of the eelgrass bed at the Lucy Islands study site. ....	105
Figure 73. Raw side scan sonar image showing piles from the temporary dock structure present at the site during the October survey. ....	106
Figure 74. Anchor pockmark in a side scan image from the April survey (top) and the corresponding video image of the pockmark (bottom). ....	107
Figure 75. 0.5 m bathymetric plot from multibeam data for the Lucy Islands study site. ....	109
Figure 76. Parallel set deployment and retrieval of a beach seine (Hahn <i>et al.</i> , 2008). ....	111
Figure 77. Traditional mooring buoy system (Project AWARE Foundation, 1996). ....	115
Figure 78. Possible anchoring systems which could be used at the Lucy Islands study site (Francour <i>et al.</i> , 2006). ....	115
Figure 79. Example of a helical screw anchor system. ....	116
Figure 80. Destruction of benthos resulting from a dragging chain on a mooring buoy (Kendall <i>et al.</i> , 2005). ....	117
Figure 81. Examples of mooring systems which prevent the mooring chain from dragging through the benthos. ....	117
Figure 82. Example of a mooring pile with a floating collar (Sluys, 1982). ....	118

Figure 83. Tackle system for a helical screw anchoring system (JCMRC Eelgrass Protection Work Group, 2010). ..... 120

Figure 84. Region where placement of a fixed anchor system may be possible at the Lucy Islands study site..... 122

Draft

## List of Tables

Table 1. Algal abundance and diversity at the north side of the Lucy Islands site.....	43
Table 2. Eelgrass abundance at the north side of the Lucy Islands site. ....	43
Table 3. Faunal abundance and diversity at the north side of the Lucy Islands site.....	55
Table 4. Diversity indices for the north side of the Lucy Islands site.....	59
Table 5. Analysis of high definition drop camera photographs. ....	66
Table 6. Comparison of eelgrass abundance between surveys. ....	76
Table 7. Temporal variations in eelgrass height.....	96
Table 8. Faunal abundance and diversity from beach seines at the Lucy Islands site. ....	110
Table 9. Bird abundance and diversity in the region of Lucy Islands. ....	113
Table 10. Substrate type codes.....	132
Table 11. Average particle size values.....	133
Table 12. Percentage substrate cover codes.....	133
Table 13. Average percentage substrate cover values.....	133
Table 14. Vegetation codes.....	134
Table 15. Vegetation coverage codes.....	135
Table 16. Average percentage vegetation cover values.....	136
Table 17. Fauna codes.....	136
Table 18. Faunal distribution classes.....	139
Table 19. Photographs of organisms caught during beach seining.....	140



## **Executive Summary**

Eelgrass beds are both ecologically valuable and potentially threatened. They fall within the “critical” category of DFO’s habitat rating system, and DFO has concluded that eelgrass has characteristics which meet the criteria of an Ecologically Significant Species. The United Nations recently estimated a 15% loss in seagrass habitat globally over the last decade.

The Lucy Islands lie in the middle of Chatham Sound, approximately 21 km west of the city of Prince Rupert. They are a nationally listed important bird area (IBA), supporting a globally significant population of rhinoceros auklets. The Lucy Islands Provincial Conservancy is a new conservancy that was established pursuant to government’s land use decision for the North Coast planning area.

Although the North Coast 2000 Aerial Video Imaging Survey showed no eelgrass visible around the Lucy Islands, eelgrass beds had been observed in the lower intertidal and subtidal regions during boat trips to the islands. Thus, in 2010, Ocean Ecology and WWF jointly applied for, and received, a research grant from MEC to carry out a study of the eelgrass beds at the Lucy Islands.

The purpose of the Lucy Islands Eelgrass Study was to investigate the productivity and ecological roles of, as well as the impacts of climate change and human activities on, eelgrass in northern B.C.

The objectives of the Lucy Islands Eelgrass Study were the following:

1. To assess the productivity and ecological roles of eelgrass on the north coast. Eelgrass beds in northern B.C. are frequently smaller, deeper, and are found over a wider range of bottom types than eelgrass beds in southern B.C. Their ecological roles and their relationships to closely associated marsh grass habitats in northern B.C. are poorly understood.
2. To compare the productivity of the Lucy Islands’ eelgrass bed with other eelgrass beds, such as Flora Bank, in the Skeena River estuary region in order to better understand the relationships between global climate changes, changes in river flow and sedimentation patterns, and changes in eelgrass productivity.
3. To assess the damage caused to the Lucy Islands’ eelgrass bed by the use of anchors during the course of recreational boater activities in the area. Possible solutions to this problem were evaluated.
4. To provide a clearer understanding of the ecological relationship of the Lucy Islands’ eelgrass bed to the Lucy Islands’ role as an established IBA for rhinoceros auklets, pigeon guillemots, glaucous winged gulls, and black oystercatchers.
5. To assess the use of side scan sonar as a tool to quantify subtidal eelgrass beds.

Three surveys were carried out at different seasons: (1) summer - July 17th to July 19th, 2010; (2) fall - October 27th, 2010; and (3) spring - April 20th, 2011.

During these surveys, the following information was collected: (1) towed benthic video camera footage; (2) high definition video drop camera photos; (3) side scan sonar imagery; (4) multibeam and single-beam bathymetry; (5) identification and enumeration of fish and mobile invertebrates from beach seining; and (6) bird, mammal, and human activity observations

The following conclusions were made from the Lucy Islands Eelgrass Study:

1. Eelgrass in northern B.C. is subject to large tidal ranges, strong currents, and heavy winter storm activity. At the Lucy Islands study site, strong currents and storm waves produced seasonal sand migration, with the sand moving offshore to sand bars in the winter and back to the intertidal beach area in the summer. Eelgrass was most abundant at the site in areas of mixed pebble, cobble, and sand substrate. The presence of pebbles and cobbles probably reduced the sand migration, thus increasing substrate stability and preventing up-rooting and loss of eelgrass plants. This may explain why eelgrass in northern B.C. is found more commonly in mixed substrate than in southern B.C.
2. Eelgrass abundance and distribution was greatest in the summer. During the fall, in response to decreased light, both eelgrass and macroalgae growth at the site decreased. Heavy storm activity resulted in the erosion and removal of much of the flora biomass at the site.
3. Macroalgae reached its maximum biomass in April, whereas eelgrass did not reach its maximum biomass until sometime after July.
4. During the spring, summer, and fall surveys of the Lucy Islands study site, a total of 14 species of macroalgae, 49 species of marine fauna, and 17 species of birds were observed. Species richness was greatest in spring and summer, and least during the fall. During the fall survey, juvenile salmon, most likely chinook, were present in schools at the site. Dungeness crabs were also present in both the summer and fall surveys.
5. High species richness during the spring and summer was correlated with high eelgrass density. The eelgrass is clearly providing suitable niches for a number of organisms. Eelgrass beds probably function to stabilize the mobile sand substrate, thus providing areas where other organisms can become anchored, such as algae and sessile fauna. Mobile fauna find food and refuges from predators in the eelgrass blades. Birds are more common on the islands during the times when marine fauna are most abundant, and are probably feeding on these organisms.
6. While the Lucy Islands eelgrass bed receives terrestrial nutrients from the Skeena River, it does not experience the full impact of the plume turbidity, and thus eelgrass may be found growing to depths of 2 - 3 m. In contrast, very little subtidal eelgrass was seen growing at Flora Bank, which is located within the turbid region of the plume year round and is severely light limited. The presence of river-derived nutrients at the Lucy Islands allows lush eelgrass growth to occur.
7. Global warming may lead to reduced snow packs as a result of increasing average temperatures, but may also increase the intensity of fall storms. Precipitation falling as heavy rain rather than snow has the potential to increase the volume of sediment entering the river. Increased riverine sediment may cause eelgrass beds closest to the mouth of the river to experience increased turbidity, which could lead to reduced growth. However, eelgrass beds at the edge of the Skeena plume may avoid this sedimentation effect, either partially or totally, and continue to function as healthy ecosystems. Mobile organisms, such as a juvenile fish, may end up using the "outer" eelgrass beds in preference to "inner" beds which have become silted over.
8. Evidence of anthropogenic damage to the eelgrass bed was rapidly obliterated by moving sand at the Lucy Islands site. However, constant up-rooting of eelgrass plants will eventually decrease the productivity of the eelgrass bed, increase the mobility of the substrate, and create a habitat which is less rich and diverse than the one which presently exists at the site. Since the site is located at the trailhead of the Lucy Islands trail, which will encourage anchoring at the site, it is recommended that some type of fixed anchor system be put in place at the site. Two potential systems have been recommended: (1) a helical screw anchor system; and (2) a steel piling with a float collar.

9. More species of birds were present, and the overall number of individual birds was higher, when the eelgrass was most abundant. A likely hypothesis is that when eelgrass is abundant, it provides both a source of food and a protective habitat for many species of marine fauna. These organisms, in turn, serve as prey items for marine birds. This may be of particular importance to nesting birds whose foraging range may be reduced by the requirements to incubate eggs and guard the nest and hatchlings.
10. The image quality of the side scan data produced by the Humminbird 997c SI unit was comparable with that of images produced by more expensive systems. In light of the significant difference in set-up costs between the Humminbird system and other systems used in scientific research, this is a significant outcome. It may make it possible for small organizations with limited funding to be able to collect high quality side scan data.
11. Two side scan processing techniques were used to assist in the identification and measurement of eelgrass areal coverage in side scan images: (1) texture analysis using grey level co-occurrence matrices (GLCM); and (2) false coloring of back scatter intensity. Both techniques have significant potential usefulness for future eelgrass surveys, but will need a bit more “fine-tuning”.
12. Measurement of eelgrass height using the downward-looking sonar was very successful. While this technique does not differentiate between eelgrass and macroalgae, once an eelgrass bed has been located, this method could be used to track changes in eelgrass height, and thus productivity, throughout the year or over the course of several years.

## 1 Introduction

Eelgrass beds are both ecologically valuable and potentially threatened. They provide rearing habitats for the juvenile stages of many species of fish, foraging habitats for both migratory and resident bird species, and play a role in carbon sequestering. However, our understanding of their ecological functions and the impacts of human activities and climate change on them is limited.

Eelgrass beds fall within the “critical” category of DFO’s habitat rating system, and are considered a “habitat essential because of its rarity, productivity and sensitivity” and/or a “habitat essential to sustaining a subsistence, commercial or recreational fishery or species at risk”. Furthermore, they may have the “presence of high-value spawning or rearing habitat” and/or “areas high in primary productivity” (G3 Consulting Ltd., 2003). In 2009, a DFO Science Advisory Report made the following conclusion:

“Eelgrass (*Zostera marina*) in eastern Canada has characteristics which meet the criteria of an Ecologically Significant Species. If the species were to be perturbed severely, the ecological consequences would be substantially greater than an equal perturbation of most other species associated with this community.”

Loss of eelgrass and other seagrass populations is a worldwide phenomenon largely associated with anthropogenic stresses. Eelgrass populations have been lost in virtually all areas of intense human settlement. On the east coast of the U.S., loss of eelgrass as of 2003 was estimated to be in the order of 20% north of Cape Cod, Massachusetts, while as much as 65% of eelgrass had been lost south of Cape Cod where the coast is more heavily populated and industrialized (DFO, 2009). The United Nations recently estimated a 15% loss in seagrass habitat globally over the last decade (Wright, 2004). Recent reports by the United Nations Environmental Protection Department demonstrate the value and urgency of seagrass conservation:

“We are becoming aware of the role that seagrasses plays in the climatic and oceanic carbon cycles and in coastal protection. The true economic value is difficult to measure, but work suggests it is immense. Seagrass beds have been overlooked by conservationists and coastal development planners throughout their range. Biosphere restoration must include seagrass conservation and restoration.”

Dr. Mark Collins, Director, United Nations Environmental Protection (quote taken from Wright, 2004).

The Lucy Islands lie in the middle of Chatham Sound, approximately 21 km west of the city of Prince Rupert. They are protected from the open waters of Dixon Entrance and Hecate Strait by the Dundas and Stephens Island groups. The Lucy Islands group consists of an archipelago of small, low-lying, forested islands. They are located within the riverine influence of the Skeena River estuary during freshet, and, as a result, receive river-derived sediments (see Figure 1). Sandy beaches and tidal mud flats connect many of the islands, and a few isolated islets are present. Other habitat types include lagoons and reefs. The island forests are composed primarily of Sitka spruce, with western hemlock being more prevalent in the interior of the larger islands. Lucy Islands and the surrounding rocky islets provide prime seabird colony habitat, with an estimated 50,000 birds using the area. The interiors of the islands tend to be mossy, with scattered shrubs that are dense in some locations, except in regions where the burrow-nesting rhinoceros auklets have eliminated the ground cover around their colonies (Ministry of Environment, 2008; IBA Canada, 2011).

The Lucy Islands are a nationally listed important bird area (IBA). They support a globally significant population of rhinoceros auklets. Surveys conducted in 1983 documented the presence of 25,300 nesting pairs (about 5.4% of the global and 7% of the estimated national population). An early survey (1976) documented a similar population, with 26,000 pairs being

recorded. The auklets nest primarily around the perimeter of most of the vegetated islands, with the colonies extending as far as 120 m inland on the main island. Lucy Islands support the sixth largest of the 19 known rhinoceros auklets colonies in British Columbia. Although no thorough estimates of the breeding population are available, large concentrations of pigeon guillemots have been recorded at this site. As many as 197 birds (1.9% of the estimated national population) were recorded among the islands in 1983. In 1984, however, only 54 pigeon guillemots were recorded. Other species nesting on the islands include glaucous winged gulls and black oystercatchers. The surrounding marine habitat is an important feeding area for marine birds (IBA Canada, 2011).

The juvenile stages of a number of commercially important fish species, as well as several ecologically important forage fish species, may be present at the Lucy Islands at certain times of the year. These species include the following:

- surf smelt (*Hypomesus pretiosus pretiosus*) - spawn on beaches with excessive surf activity throughout the year
- capelin (*Mallotus villosus*) - spawn on fine gravel beaches in late September to early October
- eulachon (*Thaleichthys pacificus*) - present off of river mouths in late spring to early summer
- chinook salmon fry (*Oncorhynchus tshawytscha*) - present from April onward
- sockeye salmon fry (*Oncorhynchus nerka*) - present during the early summer
- coho salmon fry (*Oncorhynchus kisutch*) - present during the early summer
- chum salmon fry (*Oncorhynchus keta*) - present from early spring to September
- pink salmon fry (*Oncorhynchus gorbuscha*) - present from early spring to September
- Pacific herring (*Clupea harengus pallasii*) - spawn from March through to April; larvae are present from spring to fall
- Pacific sand lance (*Ammodytes hexapterus*) - larvae are present in early summer in fine gravel and sandy substrates; spawn in the spring and again in September and October

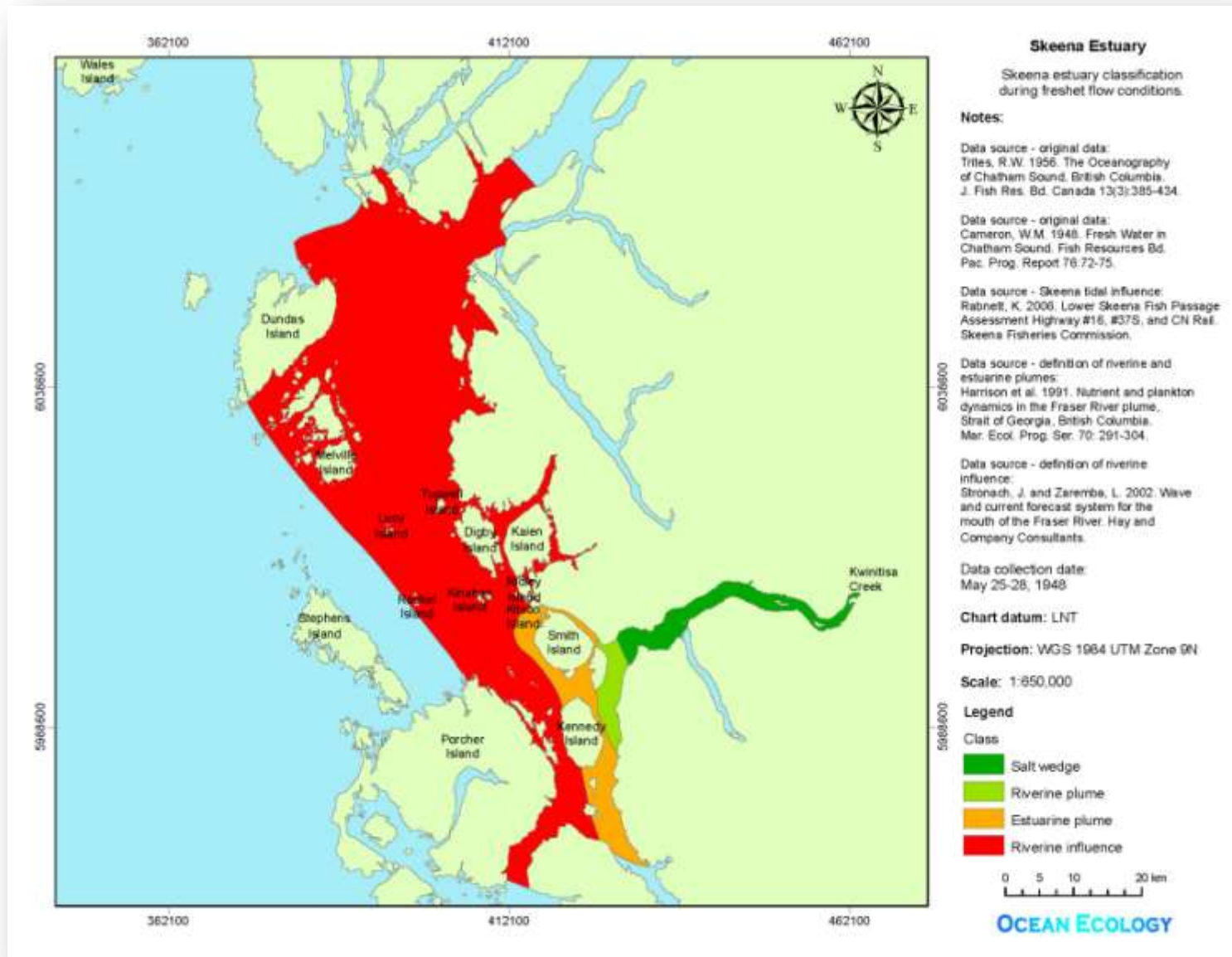

Figure 1. Location of the Lucy Islands relative to the Skeena River estuary.

In 2000, an aerial video imaging survey of the Lucy Islands was carried out by Coastal & Ocean Resources Inc. (CORI) for the Land-Use Coordination Office. Tape NC00-17 of the North Coast 2000 Aerial Video Imaging Survey provides the actual video footage of the Lucy Islands (CORI, 2000). The shoreline biophysical classification derived from this aerial survey shows no eelgrass present, although surfgrass was observed (Ministry of Sustainable Resource Management Land and Resource Data Warehouse, 2011; see Figure 2). Further examination of the video showed that no eelgrass was visible or noted during the flight. However, on trips to Lucy Islands, the author had observed extensive eelgrass beds. These beds were largely in the lower intertidal and subtidal regions, and this may be a possible explanation for why the aerial survey did not detect them. Since eelgrass is an important habitat for forage fish, some juvenile fish species, and many invertebrates, it seemed possible that there might be a relationship between the locations of these eelgrass beds around the Lucy Islands, and the islands importance as a seabird habitat.

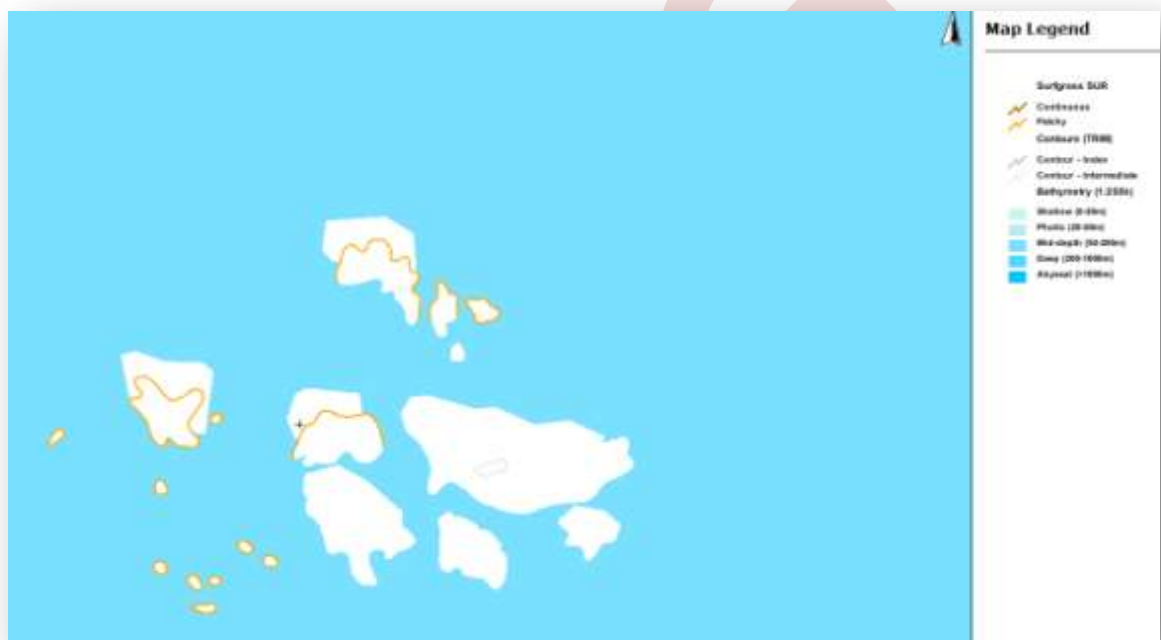

Figure 2. Shoreline biophysical classification for Lucy Islands showing location of surfgrass.

The islands, which are crown land, are currently uninhabited. A light station was located on the east point of the main island, but the light keeper's house was dismantled in 1988. The light tower itself still remains; however it is fully automated and no keepers are stationed on the islands (IBA Canada, 2011).

The Lucy Islands Provincial Conservancy (206 hectares – 28 hectares of upland and 178 hectares of foreshore) is a new conservancy that was established pursuant to government's land use decision for the North Coast planning area (Ministry of Environment, 2008; see Figure 3).

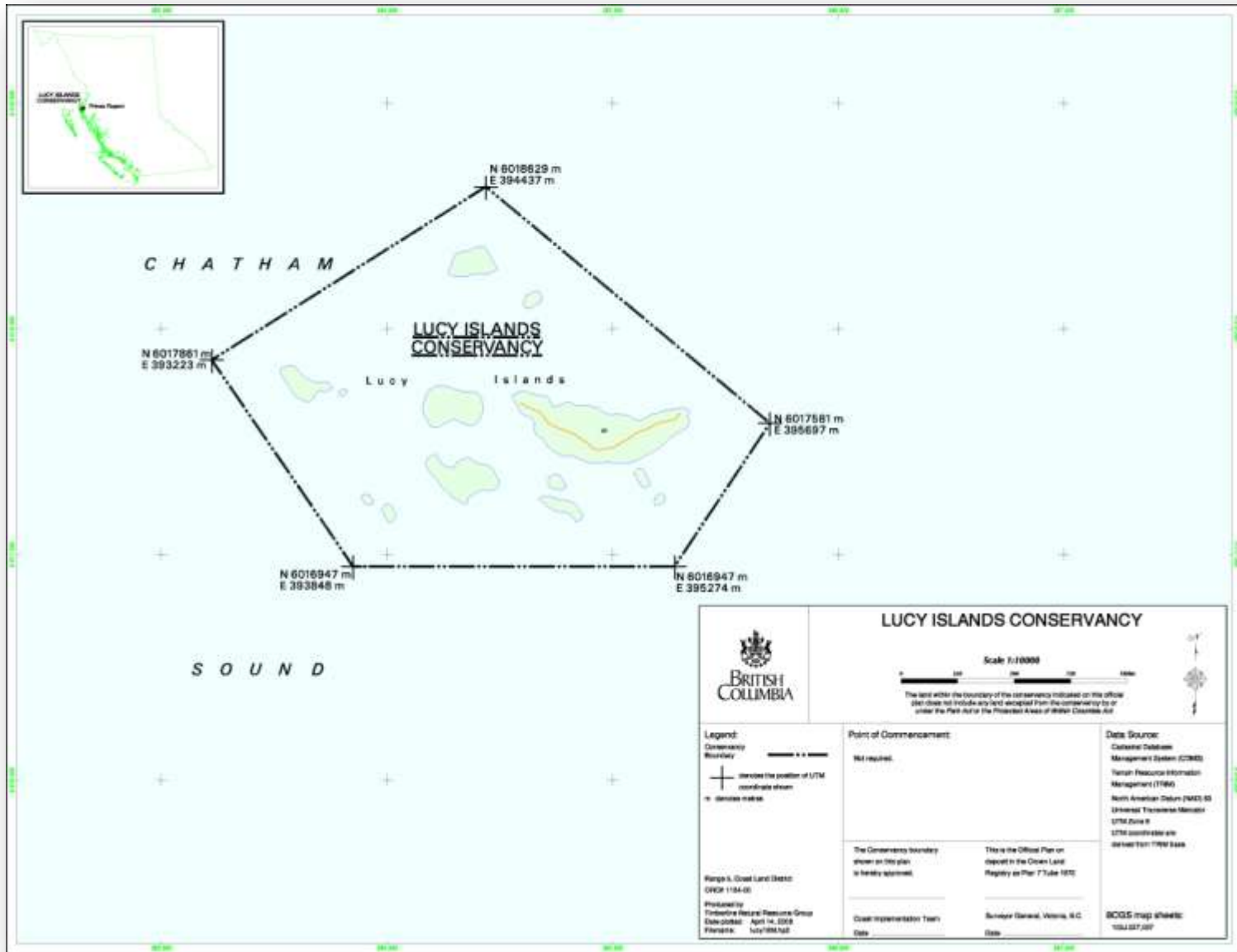

Figure 3. Location and boundaries of the Lucy Islands Conservancy.



The shallows south of the islands offer excellent fishing, making the Lucy Islands a popular destination for Prince Rupert residents. These islands are also frequented by kayakers crossing from Prince Rupert to the Melville-Dundas Islands. This conservancy is an important area for First Nation resource gathering, and is within the asserted traditional territories of the Coast Tsimshian First Nations. Lucy Islands Conservancy is accessible by boat or helicopter (Ministry of Environment, 2008).

However, the Lucy Islands proximity to Prince Rupert, a major port in northern British Columbia, places them at greater risk for oil spills, due to frequent boat traffic. Disturbance of the nesting birds by recreational boaters is also a concern (IBA Canada, 2011).

“All seabird islands and marine mammal rookeries and haul-outs are intrinsically unique and therefore singularly rare. Collectively they also are very rare, biologically significant, sensitive to disturbance, and threatened by oil spills, careless recreationists, fishermen, and introduced species - among other things. Examples include Lucy Islands...”

Jim Pojar in Rare Ecosystems of the CWHvh2, 2002

“Lucy Islands – this area is very high (use area), with one or more parties visiting location almost daily during May – October. Use is high with kayakers and small boats ... islands offering beaches, camping, hiking and wildlife viewing. Use levels are potential threat to breeding bird colonies, but availability of monitoring information is poor.”

Matthew Lamb-Yorski and Sarma Leipins from Review of Public Use in the North Coast LRMP Area, Ministry of Forests, North Coast Forest District, 2002

In 2010, Ocean Ecology and WWF jointly applied for, and received, a research grant from MEC to carry out a study of the eelgrass beds at Lucy Islands.

The purpose of the Lucy Islands Eelgrass Study was to investigate the productivity and ecological roles of, as well as the impacts of climate change and human activities on, eelgrass in northern B.C.

The objectives of the Lucy Islands Eelgrass Study were the following:

- (1) To assess the productivity and ecological roles of eelgrass on the north coast. Eelgrass beds in northern B.C. are frequently smaller, deeper, and are found over a wider range of bottom types than eelgrass beds in southern B.C. Their ecological roles and their relationships to closely associated marsh grass habitats in northern B.C. are poorly understood.
- (2) To compare the productivity of the Lucy Islands' eelgrass bed with other eelgrass beds, such as Flora Bank, in the Skeena River estuary region in order to better understand the relationships between global climate changes, changes in river flow and sedimentation patterns, and changes in eelgrass productivity.
- (3) To assess the damage caused to the Lucy Islands' eelgrass bed by the use of anchors during the course of recreational boater activities in the area. Possible solutions to this problem were evaluated.
- (4) To provide a clearer understanding of the ecological relationship of the Lucy Islands' eelgrass bed to the Lucy Islands' role as an established IBA for rhinoceros auklets, pigeon guillemots, glaucous winged gulls, and black oystercatchers.
- (5) To assess the use of side scan sonar as a tool to quantify subtidal eelgrass beds.

The location of the study site within the Lucy Islands Conservancy is shown in Figure 4.

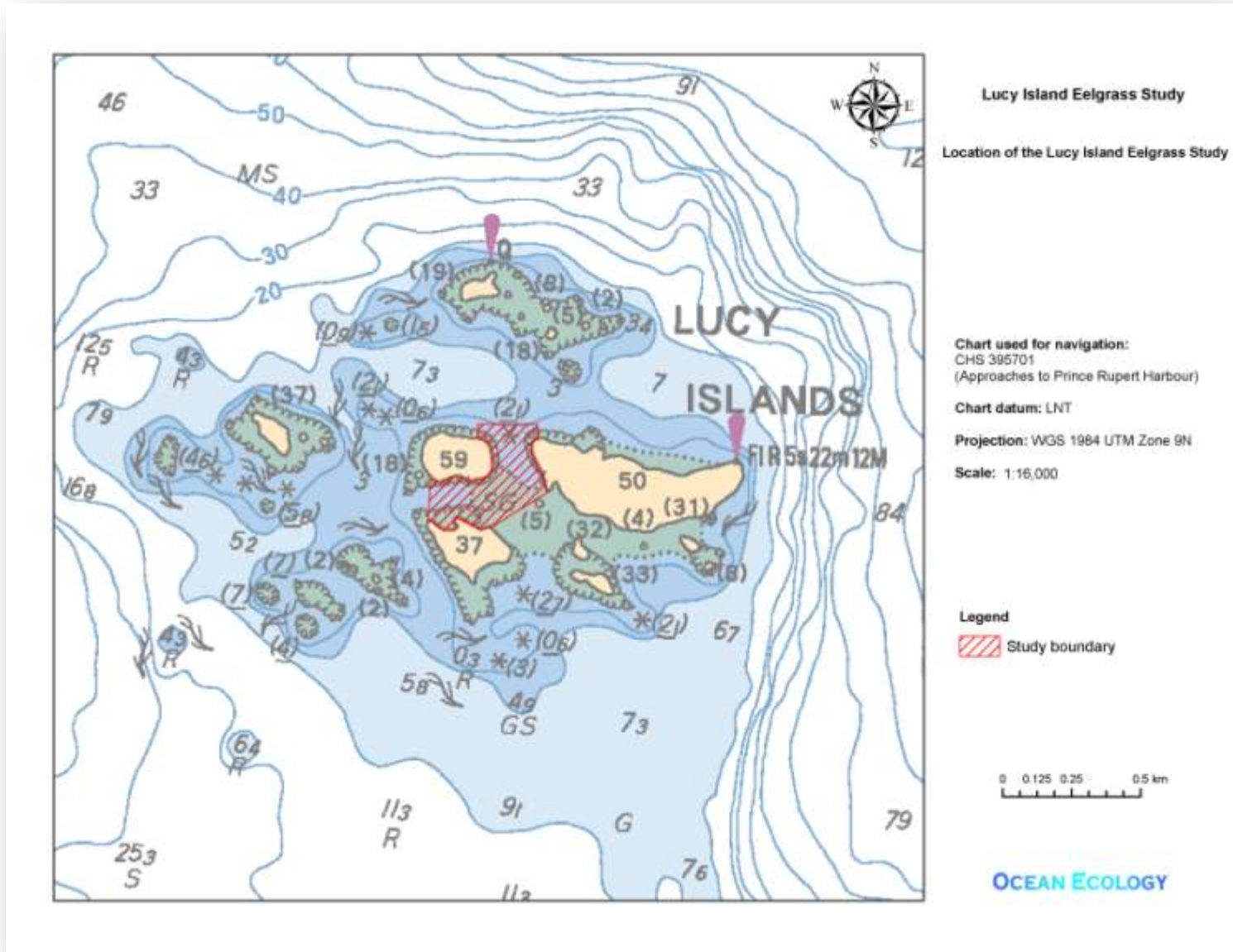

Figure 4. Location of the Lucy Islands eelgrass study.

## **2 Lucy Islands Eelgrass Survey Methodology**

### **2.1 Overall Project Design**

A complete survey of the Lucy Islands' eelgrass bed was carried out during the period of July 17<sup>th</sup> to July 19<sup>th</sup>, 2010. The extent and density of the eelgrass bed was mapped by performing a grid survey using a towed benthic video camera system. The video survey also provided information on the benthic invertebrates and fish occupying the eelgrass bed. Additional high definition video footage was taken at randomly selected sites in the eelgrass bed. The bathymetry of the eelgrass site was mapped using a combination of multibeam and single-beam techniques. A side scan sonar unit was used to visualize detailed seafloor features. This was particularly important in examining the site for anchor scars and other signs of anthropogenic damage. It also provided information on the height, patchiness, and hence productivity, of the eelgrass bed. Finally, a beach seine was carried out at the site to determine what species of small fish and mobile invertebrates were using the eelgrass bed as habitat. All data from the survey was mapped in an ArcGIS project.

Two additional shorter surveys of the site were also carried out. One occurred on October 27<sup>th</sup>, 2010, and the other occurred on April 20<sup>th</sup>, 2011. These two surveys involve doing several representative video transects of the site for comparison to the summer data, as well as additional side scan sonar and beach seine studies.

Throughout the three field trips to the site, bird and marine mammal activity in the area was recorded. Notes regarding any human activities in the area were kept.

During the winter, a short study on the feasibility of installing fixed anchors at the Lucy Islands site was done.

Data analysis and write-up of the project report occurred during the spring of 2011. Reports and maps will be posted on the web for public viewing.

## 2.2 Single-Beam Sounder Bathymetric Survey

### 2.2.1 Single-Beam Sounder System

Seafloor hardness and depth data were collected using a transducer mounted in a towfish (referred to as a mapping sounder) which was towed from the stern of the vessel at 1.5 m depth. Sounding data were recorded every second and logged on a computer. The specifications of the towfish mapping sounder and associated data collection system were:

- **Bathymetric system:**
  - JRC 130 single-beam echosounder
- **Transducer:**
  - 200 kHz operating at 1 kW power
- **Beam angle:** 17 degrees
- **Swath width:** 9 m in 30 m water depth and 0.6 m in 2 m water depth
- **Positioning system:**
  - Electronic charting software using DGPS antenna mounted directly above the towfish
- **Station for tide height corrections:**
  - Prince Rupert
  - CHS reference station 10937
- **Chart for navigation:**
  - CHS 395701 (Approaches Prince Rupert Harbour)
  - Horizontal Datum: NAD 83
  - Depth Units: Meters
  - Sounding Datum: LNT
- **LNT to geodetic (MWL) conversion:**
  - subtract 3.8 m from hydrographic charts

### 2.2.2 Survey Design

The single-beam sounder bathymetric survey was carried out on July 17<sup>th</sup>, 2010. The survey resolution was roughly a 50 m grid, with both shore-normal and shore-parallel transects. The survey transects are shown in Figure 5. Depth readings were taken once every second along both shore-normal and shore-parallel transects. The average vessel speed for this survey was 2.1 knots or 1.1 m/s. Thus, the distance between depth readings along transects was approximately 1.1 m.

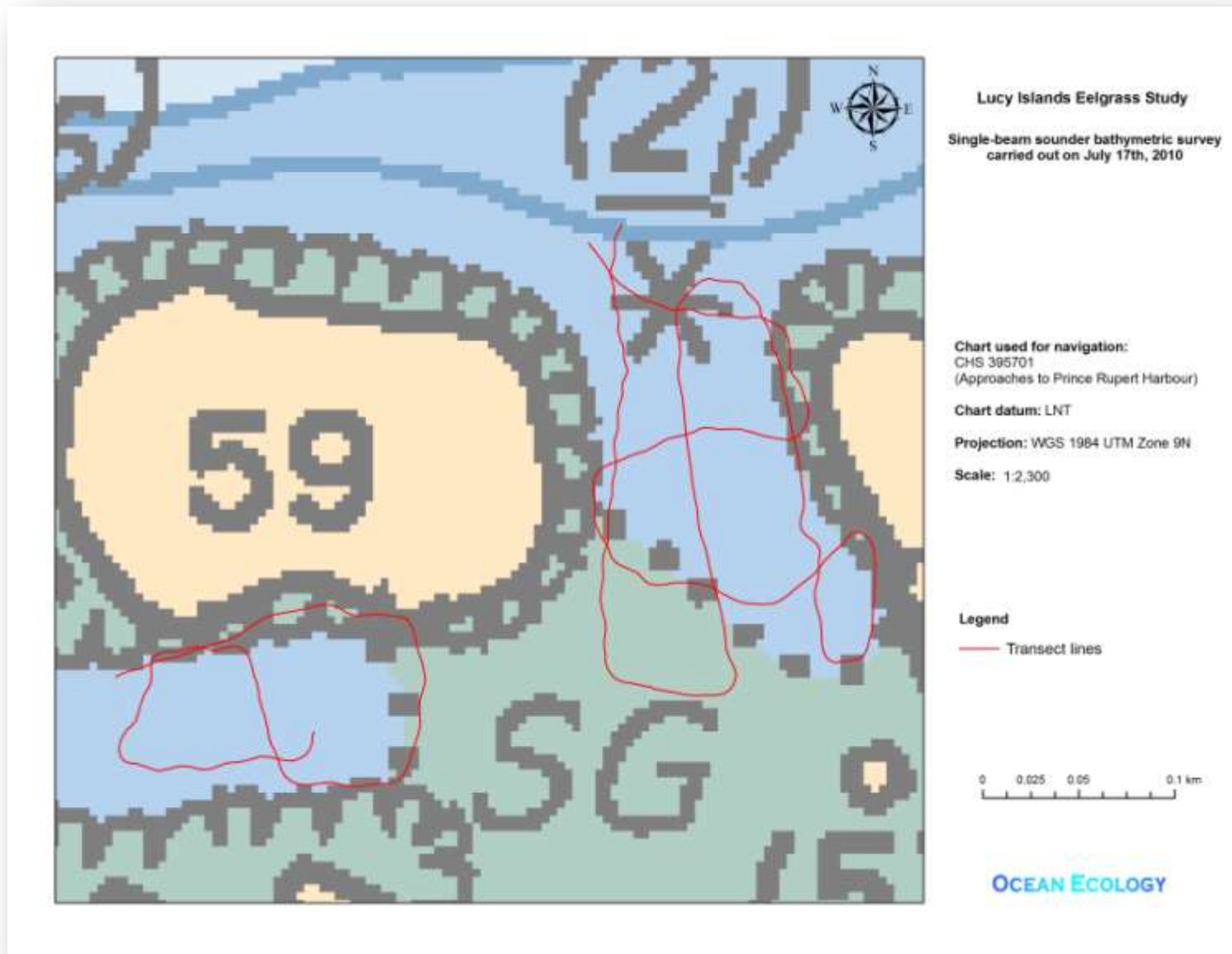

Figure 5. Single-beam sounder bathymetric survey carried out on July 17<sup>th</sup>, 2010.

### 2.2.3 *Depth Grids and Contour Plots*

The bathymetric data collected for the site were corrected for towfish depth and tidal height in ArcGIS. Tidal height values were generated for each minute of the survey using an XTides-based program. The reference station used for the tidal heights was Prince Rupert (CHS reference station 10937). The corrected data was exported from ArcGIS, and used to generate a depth grid in Surfer (a more specialized gridding and 3D surface mapping program than ArcGIS).

Shore line boundaries were estimated from the Approaches to Prince Rupert Harbour chart (CHS 395701). The depth value of the upper shoreline was set to the HHW (high high water) value, in meters, for spring tides in the Prince Rupert area (e.g. -7.5 m [7.5 m above LNT]).

The gridding method used in Surfer was Kriging. Kriging is one of the more flexible methods and generates a good map for most data sets. As a result of this, it is one of the most commonly used methods for gridding. For this study, a variogram model was run on the data before Kriging, and the results of this model were used to custom-fit the data set. Kriging is an exact interpolator. Exact interpolators honor data points exactly when the point coincides with the grid node being interpolated. However, it is possible that the grid file does not honor specific data points if the data points do not exactly coincide with the grid nodes. When this happens, Surfer uses weighted averaging. This means that, with all other factors being equal, the closer a point is to a grid node, the more weight it carries in determining the Z value at that grid node. The calculation grid nodes for the Kriging were set to a density of 4x the field transect spacing, or approximately 12.5 m. Spline smoothing increased the node density, resulting in a final grid with a 0.5 m resolution.

The depth grid was then imported back into ArcGIS, where contour plots were created. The chart datum for these plots is Lowest Normal Tide (LNT), which is consistent with the Canadian Hydrographic Service's nautical charts. The chart projection used in ArcGIS was WGS 1984 UTM Zone 9N.

## 2.3 **Towed Benthic Video Survey**

### 2.3.1 *Towed Video System*

A DGPS-positioned, towed video system was used to collect imagery of the seabed (similar to the Seabed Imaging and Mapping System [SIMS] used by CORI). This system was a custom-built model (e.g., not commercially available) designed for use in the steep, rugged terrain characteristic of British Columbia fjords (see Figure 6). Typical tow speed for the system was 0.9 knots. The towed video system has two video cameras - one in a forward-looking orientation and one in a downward-looking orientation. Both cameras have a Sony 1/3" super HAD color CCD with 480 lines horizontal resolution (768 x 494 pixels) and 0.5 lux @ F 2.0. These cameras provided composite video signals to an overlay unit that stamped the DGPS position data (latitude/longitude), together with date and time, on each video frame. The video signal was also displayed in real-time on the vessel, where it was used to adapt the survey to particular features that were seen while underway. High intensity white LEDs were mounted on the camera to provide additional illumination when it was required. On the April 20<sup>th</sup>, 2010 survey, the downward-looking camera was also equipped with a pair of scaling lasers with a center-to-center distance of 4 cm.

The altitude of the underwater camera was controlled using a hydraulic winch which was operated from the bridge while monitoring the real-time video feed from the camera. Typically, the camera was towed approximately 1 m above the seabed.



Figure 6. Towed video camera system about to be deployed.

### *2.3.2 Video Recording System*

The dual analog camera signals were recorded using a digital video recorder directly onto a hard drive. After the survey was completed, the raw video data was copied onto DVDs. As the digital video recorder creates video files in a proprietary format, software to view and convert the video data into other formats was also provided on each raw video DVD.

### *2.3.3 Survey Design*

The first benthic video survey was carried out on July 17<sup>th</sup>, 2010. Video transects were done on both sides of the sand bar located at the center of the study site (see Figure 7).

The next two benthic video surveys focused on the eelgrass bed to the north of the sand bar. These surveys occurred on October 27<sup>th</sup>, 2010 (see Figure 8) and April 20<sup>th</sup>, 2011 (see Figure 9), respectively.

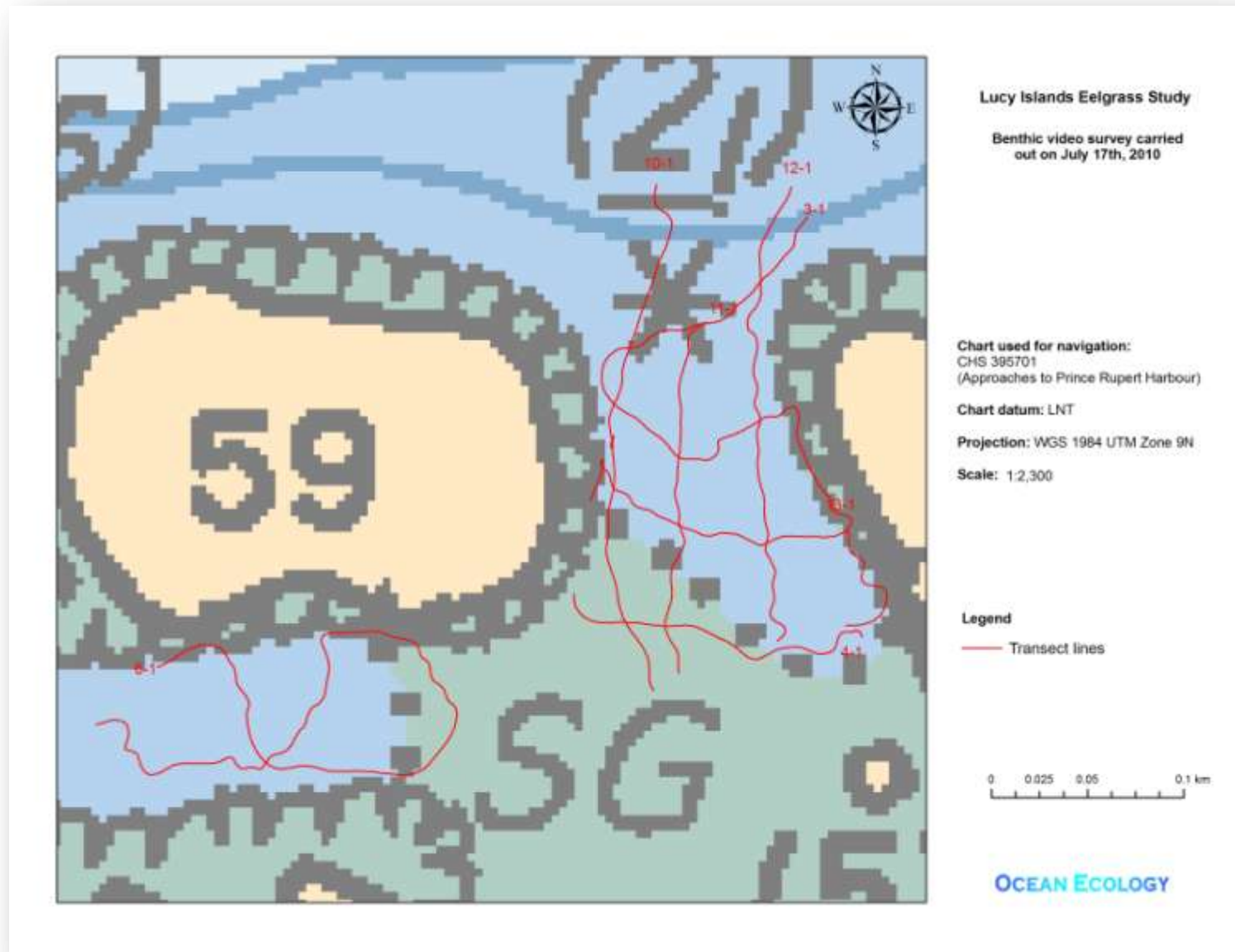

Figure 7. Benthic video survey carried out on July 17<sup>th</sup>, 2010.



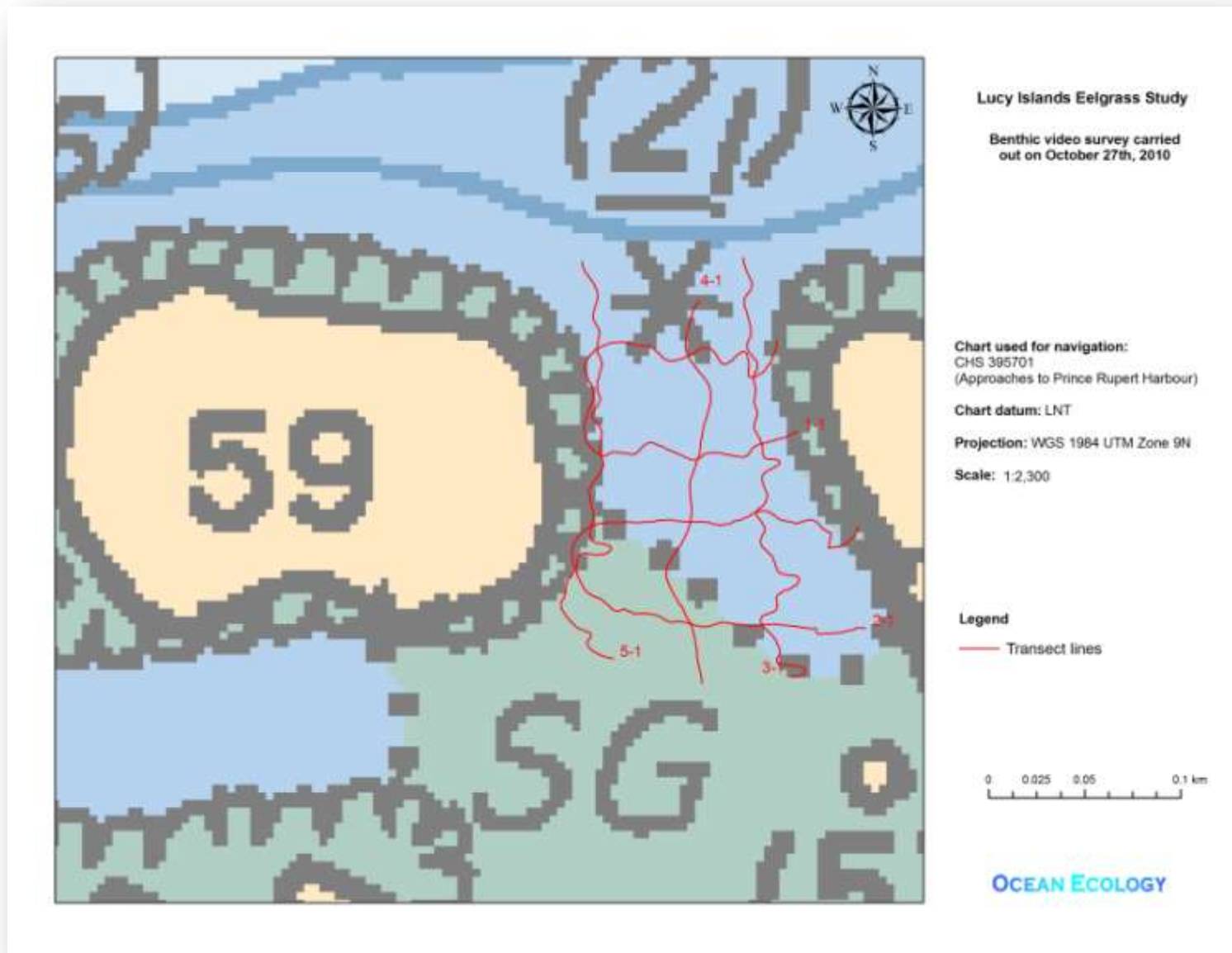

Figure 8. Benthic video survey carried out on October 27<sup>th</sup>, 2010.

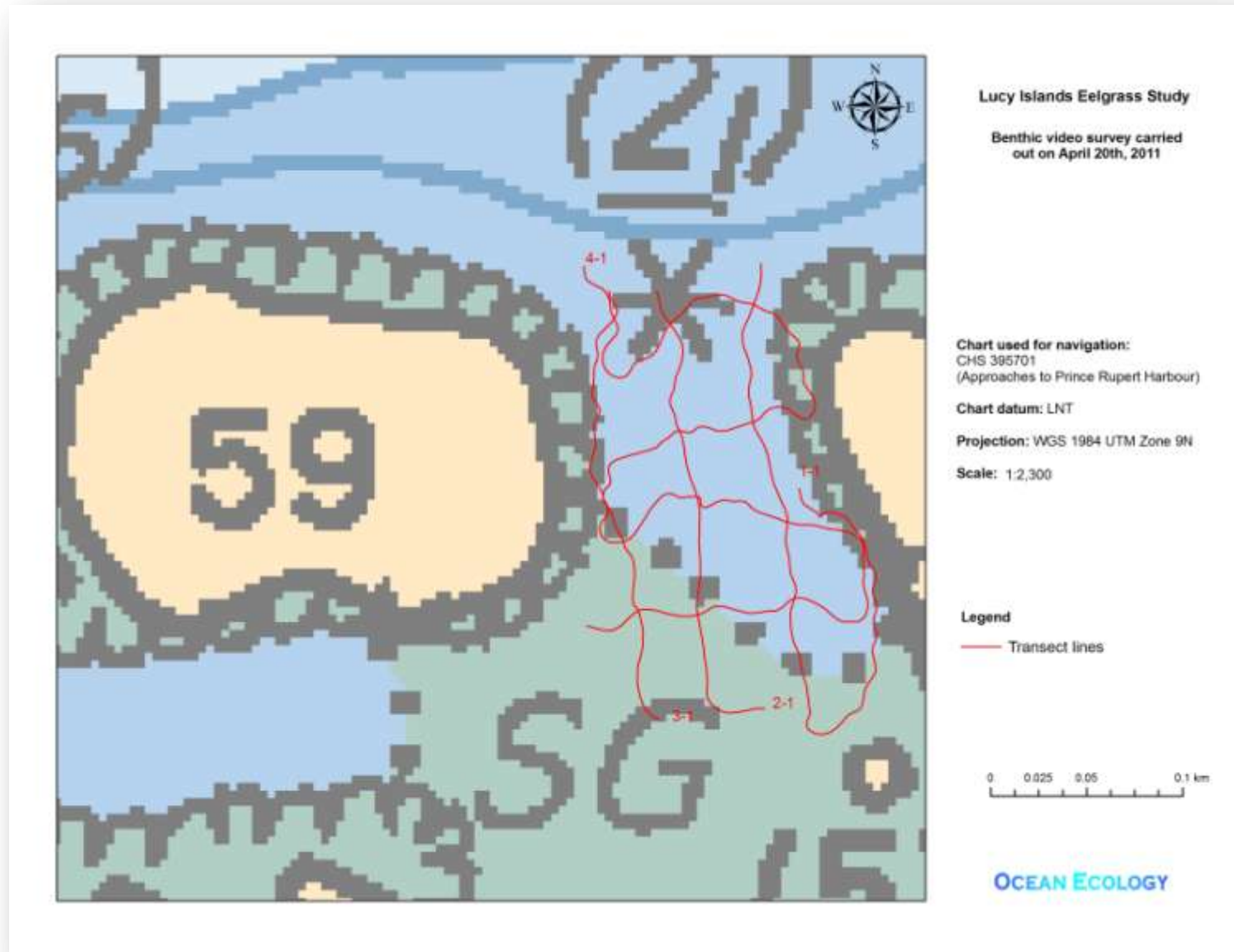

Figure 9. Benthic video survey carried out on April 20<sup>th</sup>, 2011.

## **2.4 Classification and Mapping**

### *2.4.1 Database of Species and Substrate Classifications*

Raw video of the transects was reviewed and classified using a substrate and biotic classification similar to that used by the British Columbia Land Use Coordination Office (LUCO). A data record of substrate and biota classes was produced for each second of video imagery.

The geology database contains information on substrate type (Table 10 in the Appendix) and percentage substrate cover (Table 12 in the Appendix). Anthropogenic features were mapped as part of the geological inventory.

The biological database captured detail on seabed biota within two general categories, vegetation (Table 14 in the Appendix) and fauna (Table 17 in the Appendix). Up to three faunal and floral types were evaluated for each second of video and given distribution codes. Vegetation coverage classes (Table 15 in the Appendix) and faunal distribution classes (Table 18 in the Appendix) were also recorded. Note that very small species (e.g., barnacles, small tube worms, small algal species), infauna (e.g., clams), cryptic fauna (e.g., flatfish, decorator crabs), or hidden fauna (e.g., under kelp fronds) were often not identified in the video footage, and were therefore not included in the database.

Video annotation created a linked, random-access database of all the video data which can be readily searched using keywords from the classification scheme. Additionally, the provided "Transect Player" software links video and GPS data, allowing simultaneous viewing of the camera's geographical position on a map and the video images captured by the camera at that location.

All classification data was also entered into a relational Access database, which was then used to generate the data for mapping. This database contains a "Filter by Video" function which allows the user to browse through the data for each transect as a series of data recording forms.

### *2.4.2 ArcGIS Mapping*

Maps of both (1) the observed distribution of eelgrass, and (2) the observed distribution and estimated species ranges of other species were produced using ArcGIS. These maps have been provided as an ArcGIS project which can be viewed using the supplied ArcReader.

### 2.4.3 Substrate Maps

The logarithm of average substrate particle size (*Log\_size*) based on the video observations was calculated as follows:

$$\text{Log\_size} = \log([\text{Average size substrate type 1}]^*[\text{Average percentage cover substrate type 1}]) + ([\text{Average size substrate type 2}]^*[\text{Average percentage cover substrate type 2}]) + ([\text{Average size substrate type 3}]^*[\text{Average percentage cover substrate type 3}])$$

where “*substrate type 1*”, “*substrate type 2*”, and “*substrate type 3*” are the three dominant substrates observed during each second of the video imagery. Note that entries for “*substrate type 2*” and “*substrate type 3*” were omitted if less than three substrate types were present. Shell, organic debris, wood debris, and anthropogenic substrates were not used in calculating the *Log\_size* value. The average particle size values and percentage substrate cover values are given in Table 11 and Table 13 in the Appendix.

The calculated *Log\_size* values were used to generate a grid in Surfer. This grid was then imported back into ArcGIS, where contour plots were created. The chart projection used in ArcGIS was WGS 1984 UTM Zone 9N.

### 2.4.4 Range Maps

Range maps for flora and fauna were generated using the fixed kernel density estimation procedure. Flora observations were weighted by abundance (see Table 15 in the Appendix) and fauna observations were weighted by distribution (see Table 18 in the Appendix). In order to allow overlap of polygons between transects, the search radius (a.k.a. the smoothing factor) was set to the distance between shore-parallel transects (e.g., 50 m). For each organism, a 95% volume contour was generated. This consisted of a polygon covering a geographical area in which 95% of the estimated population was expected to be found.

### 2.4.5 Eelgrass Maps

Eelgrass intensity maps were generated using the fixed kernel density estimation procedure. Eelgrass observations were weighted by the percentage cover. In order to allow overlap of polygons between transects, the search radius (a.k.a. the smoothing factor) was set to the distance between shore-parallel transects (e.g., approximately 50 m). A density plot of the eelgrass distribution was produced, and contours indicating the regions in which 50%, 90%, 95%, and 99% of the eelgrass was expected to be located were drawn.

An eelgrass grid was generated from the average percentage cover value using Surfer. The average percentage vegetation cover values are given in Table 16 in the Appendix. This grid was then imported back into ArcGIS, where contour plots were created. The final grid had a cell size of 0.5 m. The chart projection used in ArcGIS was WGS 1984 UTM Zone 9N.

#### *2.4.6 Diversity Analysis Using Range Maps*

Calculations of Shannon's diversity index, Shannon's evenness, and Simpson's dominance index were carried out in ArcMap using the range map polygons. Note that the diversity values generated from the range map data should be considered minimum values for the site, as very small species (e.g., barnacles, small tube worms), infauna (e.g., clams), cryptic fauna (e.g., flatfish, decorator crabs), or hidden fauna (e.g., under kelp fronds) are often not identified in the video footage, and are therefore may not included in the diversity calculations.

#### *2.4.7 Species Richness Maps*

A hexagonal grid (composed of hexagonal polygons with widths of 12.5 m) was overlaid on a shape file containing the range map polygons for all species. Using polygon in polygon analysis, each hexagonal polygon was assigned a number equal to the number of range map polygons with which it overlapped. This assigned number was equal to the species richness in a given hexagonal polygon, since each range map polygon represented a different species. The coded hexagonal polygons were used to generate a species richness map.

## **2.5 High Definition Drop Camera Survey**

### *2.5.1 Drop Camera System*

A DGPS-positioned, high definition drop camera system was used to collect high resolution still photographs of the seabed. This system consisted of a dual Ethernet/analog output high definition video camera in a water tight housing mounted in a “lander” frame (see Figure 10). The lander frame was designed to hold the camera at a specific elevation above the sea floor with a known field of view, and to minimize movement of the camera system so that blurring of the photographs was reduced. The lander frame had a 0.25 m<sup>2</sup> base footprint, which matches the standard quadrat size used by many shore survey protocols. The height of the camera was adjusted in the frame such that the field of view of the camera matched the lander footprint, and was thus also 0.25 m<sup>2</sup>.



Figure 10. High definition drop camera in the lander frame.

The camera used in the video system was a 5.0 MP IQeye 755 with a maximum resolution of 2560 x 1920 pixels. It operates very well in low-light conditions, with a 0.3 lux sensitivity for color images and < 0.05 lux sensitivity for black and white images. Power consumption is less than 2.5 W, which made the camera ideally suited for a remotely-powered system. The camera has both a full time analog video output (NTSC/PAL standard) and an Ethernet output which allows live streaming of high definition video and images, as well as control over the various camera settings. Since it was not possible to have an Ethernet connection to the camera while it was underwater, the camera was set up to record high definition images to an onboard CF card every 2 seconds. Live video from the camera was viewed real-time on the vessel during deployment using the analog output. When the camera was brought to the surface, the Ethernet cable was attached, and the recorded images were downloaded to a computer.

High intensity white LEDs were mounted on the camera to provide additional illumination when it was required. Both the camera and the light ring were powered remotely using a POC (power over coaxial) system.

### *2.5.2 Survey Design*

The high definition drop camera survey was carried out on July 19<sup>th</sup>, 2010. 15 drops were performed in a random pattern across the width of the bed on the north side of the sand bar (see Figure 11). For each drop, the ship was brought to a stop, and the high definition drop camera was lowered to the bottom. Using the live analog signal received from the camera, the position of the lander frame was checked for stability. After a waiting period to allow all stirred up sediment to drift away, the video system was held in position for approximately 10 seconds to provide sufficient time for a number of 5.0 MP images of the bottom to be recorded by the system. The drop camera was then raised to the surface for redeployment at the next drop location.

### *2.5.3 Photograph Analysis*

The best photograph for each camera drop was selected, imported into ArcMap, and georeferenced. All flora and fauna present in the photograph were identified. The total area occupied by eelgrass in each quadrat was accurately calculated in ArcMap.

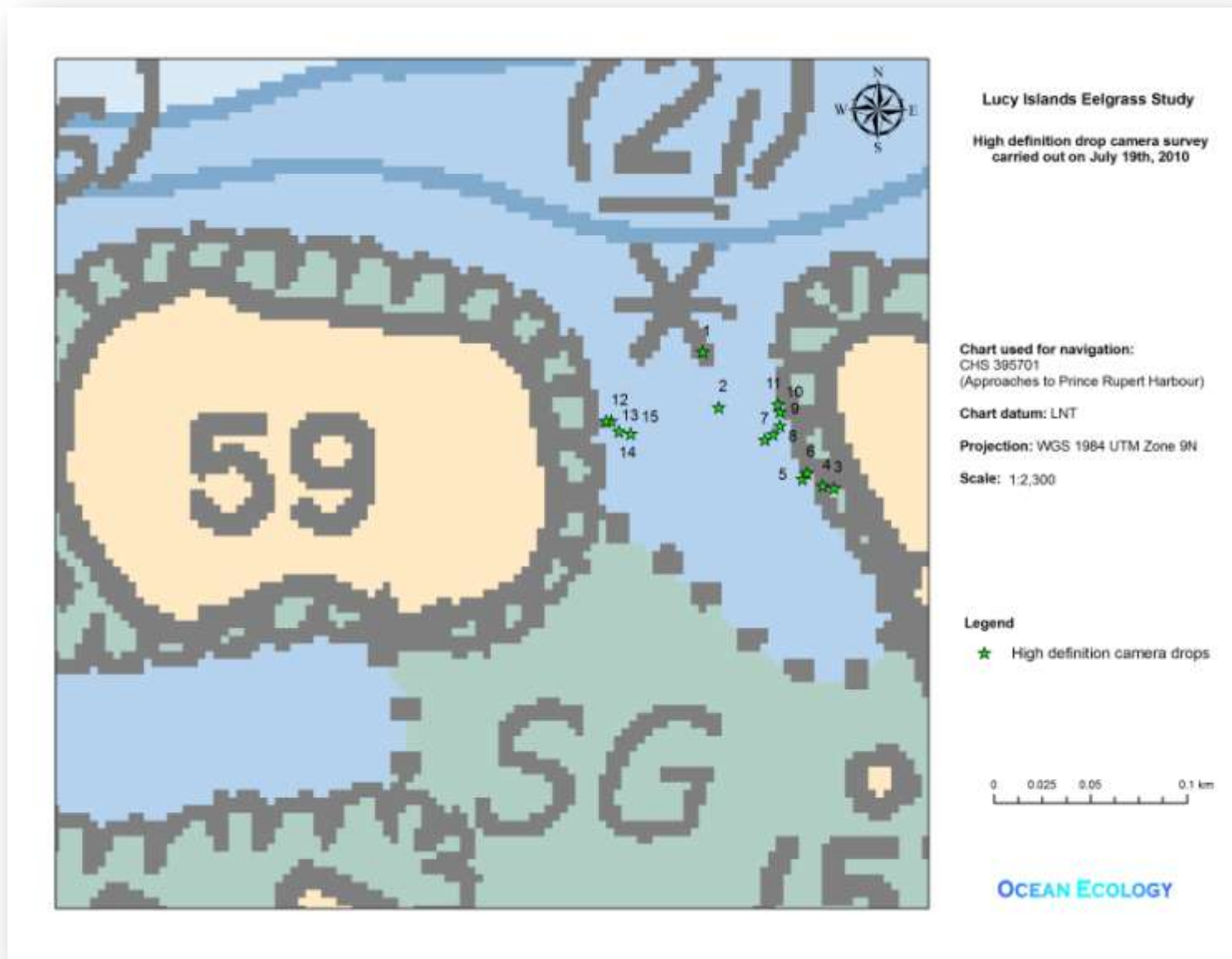

Figure 11. High definition drop camera survey carried out on July 19<sup>th</sup>, 2010.



## 2.6 Side Scan Sonar Survey

### 2.6.1 Side Scan Sonar System

Side scan sonar images were collected using a Humminbird 997c SI sonar unit operating at 455 kHz. Simultaneously, the Humminbird unit also collected seafloor depth data using a downward-looking sonar operating at dual 83 and 200 kHz frequencies. The transducer for the Humminbird unit is mounted in a towfish which was towed from the stern of the vessel at 2 m depth (see Figure 12). Side scan and downward-looking sonar data were recorded to an SD card in the proprietary Humminbird SON file format.

The specifications of the side scan sonar towfish and associated data collection system were:

- Specifications of downward-looking sonar:
  - 200 kHz beamwidth at -3dB = 14°
  - 83 kHz beamwidth at -3dB = 42°
  - Transducer depth range: approximately 450 m
- Specifications of HDSI (high-definition side imaging) transducer (best for shallow water use) at 455 kHz:
  - Horizontal beamwidth at - 3dB = 1.7°
  - Vertical beamwidth at -3 dB = 59°
  - Transducer tilt angle from vertical = 48°
  - Transducer depth range: approximately 45 m
- Power output of unit: 1000 Watts (RMS)
- Swath width: 270 m in 30 m water depth and 18 m in 2 m water depth
- Positioning system: Electronic charting software using DGPS antenna mounted directly above the towfish



Figure 12. Side scan sonar towfish in towing position.

### 2.6.2 Survey Design

The three side scan sonar surveys focused on the eelgrass bed to the north of the sand bar. These surveys occurred on July 18<sup>th</sup>, 2010, October 27<sup>th</sup>, 2010, and April 20<sup>th</sup>, 2011, respectively, at high slack water. For each survey, a series of north-south oriented, parallel, overlapping side scan sonar images were created of the sea floor.

### 2.6.3 Viewing of Raw Side Scan Sonar Data

Raw side scan data from the Humminbird 997c SI unit was visualized directly using the HumViewer freeware created by Martin Johansen (<http://humviewer.cm-johansen.dk/>).

### 2.6.4 Simple Georeferencing and Mosaicing of the Side Scan Sonar Data

Side scan data was georeferenced and projected using the software Deep View Publisher. Electronic noise removal was carried out using the open source image processing software Fiji (ImageJ; <http://fiji.sc/wiki/index.php/Fiji>). Finally, to produce a simple mosaic, the overlapping side scan sonar images were combined into a single image using ArcGIS.

### 2.6.5 Calculation of Eelgrass Cover Using Grey Level Co-occurrence Matrices (GLCM)

Texture is one of the important characteristics that can be used to identify particular regions in an image. A texture analysis of the backscatter information from a side-scan sonar image can be used to classify the seafloor. The most common method of texture analysis is based on determination of the statistical features of the grey-level co-occurrence matrices (GLCM). The GLCM is a tabulation of how often different combinations of pixel brightness values (grey levels, where the darkness of the grey refers to the intensity of backscatter) occur in an image. The GLCM characteristics give a detailed description of the contrast and correlation of the intensity of pixels in a backscatter image. For each GLCM derived from the backscatter data from a side scan image, one can calculate a large number of different textural characteristics (a.k.a Haralick textures), such as homogeneity, dissimilarity, correlation, variance, mean, entropy, contrast, angular second moment, grey-level difference vector (GLDV) contrast, GLDV mean, GLDV angular second moment, and GLDV entropy. However, most of the GLCM characteristics provide little information with respect to seafloor classification because they are not adequately correlated with the actual physical and morphological properties of the seafloor (Penrose *et al.*, 2005).

It was experimentally determined that the GLCM characteristics contrast and dissimilarity were most correlated with the presence (e.g., texture) of eelgrass in the side scan sonar images. This is in contrast to the characteristics of entropy (used to differentiate rough from smooth textures) and homogeneity (used to determine the amount of local similarities in a given area) generally used to describe side scan sonar images (Blondel *et al.*, 1998).

The open source image processing software MIPAV (Medical Image Processing, Analysis, and Visualization; <http://mipav.cit.nih.gov/>) was used to calculate the GLCM contrast and dissimilarity characteristics from the denoised side scan sonar images.

Correspondence analysis (CA) was then carried out on the GLCM contrast and dissimilarity characteristics for the side scan sonar image using the open source image processing software Fiji (ImageJ; <http://fiji.sc/wiki/index.php/Fiji>). Correspondence analysis is an exploratory data analytical technique designed to identify systematic relations between variables (e.g., contrast and dissimilarity) when there are no *a priori* expectations as to the nature of those relations. In this case, correspondence analysis was used to simplify the GLCM data and extract the important relationships between the components.

Finally, Fiji was used to perform spatial fuzzy c-means clustering on the results from the correspondence analysis. Clustering is the assignment of a set of observations into subsets (called clusters) so that observations in the same cluster are similar in some sense (e.g., belong to the "eelgrass" subset or belong to the "not eelgrass" subset). In fuzzy clustering, each point has a degree of belonging to clusters, as in fuzzy logic, rather than belonging completely to just one cluster. Thus, points on the edge of a cluster may be in the cluster to a lesser degree than points in the center of cluster. This technique is very useful for clustering objects in an image.

To produce mosaic of the eelgrass clusters, the overlapping side scan sonar images were combined into a single image using ArcGIS.

#### *2.6.6 Processing of Side Scan Sonar Data*

More complex image processing was performed by converting the raw side scan sonar data files into a format which could be imported into either the Mini Image Processing System (MIPS; <http://terraweb.wr.usgs.gov/software/mips/>), an open source image processing software developed by the United States Geological Survey (USGS) or MB-System ([http://www.mbari.org/data/mbsystem/html/mbsystem\\_home.html](http://www.mbari.org/data/mbsystem/html/mbsystem_home.html)), an open source image processing software developed by the Monterey Bay Aquarium Research Institute (MBARI) (Faggetter, 2010a, 2010b, 2010c).

#### *2.6.7 Bottom Hardness*

Since the type of seafloor substrate has an impact on eelgrass distribution, bottom hardness (e.g., a measure of the softness or hardness of the substrate) was measured using the second, or E2, echo from the 200 kHz downward-looking beam of the side scan sonar.

The backscatter of the sound pulse can be analyzed to provide information regarding the nature of the seafloor (e.g., roughness, hardness). An echo from a sounder contains two major components - E1 (first echo) and E2 (second echo). Each echo is generated by a different type of interaction with the seafloor, and thus each carries different information about the seafloor. The E1 echo is a direct reflection from the seabed, whereas the E2 echo has a transducer/bottom/sea surface/bottom/transducer path (i.e., it has interacted once with the sea surface and twice with the bottom). The E1 echo can be used to obtain information about the scattering of the sound pulse from the seafloor, and thus gives seafloor roughness, whereas the E2 echo gives information about reflection and sound absorption, and thus provides data on seafloor hardness.

Note, however, that while the double bottom interaction of the E2 echo causes it to be strongly affected by the acoustic bottom hardness, seafloor roughness has a secondary, and not always negligible, effect. Thus, the E2 signal is often referred to as "hardness", implying a measure of mechanical hardness, but in reality, it is a measure of acoustic reflectivity with some unknown relationship to seabed conditions. Since the reflection of the E2 signal from the seafloor can be affected by both the acoustic hardness and the acoustic roughness of the seafloor, a hard rough surface can scatter so much energy that it appears acoustically softer than expected. In deep sea applications "Reflection from a very rough rocky bottom may appear to be less than that from a muddy sediment" (Brekhovskikh and Lysanov, 1982). For this reason, interpretation of hardness results from the E2 echo can be somewhat subjective, and ground-truthing using video was also carried out.

Using software written by Ocean Ecology, bottom hardness was derived from the raw data recorded for the downward-looking sonar of the Humminbird 997c SI unit (Faggetter, 2010d). The bottom hardness data were used to generate a grid in Surfer. The hardness grid was then imported back into ArcGIS, where contour plots were created. The chart projection used in ArcGIS was WGS 1984 UTM Zone 9N.

#### *2.6.8 Calculation of Eelgrass Height*

Experimental software written by Ocean Ecology was used to extract eelgrass height information from the downward-looking sonar data recorded by the Humminbird 997c SI unit (Faggetter, 2010d). A contour plot of eelgrass height was then generated using Surfer and ArcGIS. The chart projection used in ArcGIS was WGS 1984 UTM Zone 9N.

*2.6.9 Macrophyte Height Profiles*

Cross-sectional profiles of macrophyte height from the Lucy Islands study site were generated using ArcGIS. The lines used for the profiles are shown in Figure 13.

*2.6.10 Observations of Anthropogenic Disturbances in the Eelgrass Bed*

Each individual georeferenced side scan image was examined for signs of anchor scars or other disturbances in the eelgrass bed. Any disturbances were marked out using polygons in ArcGIS.

Draft

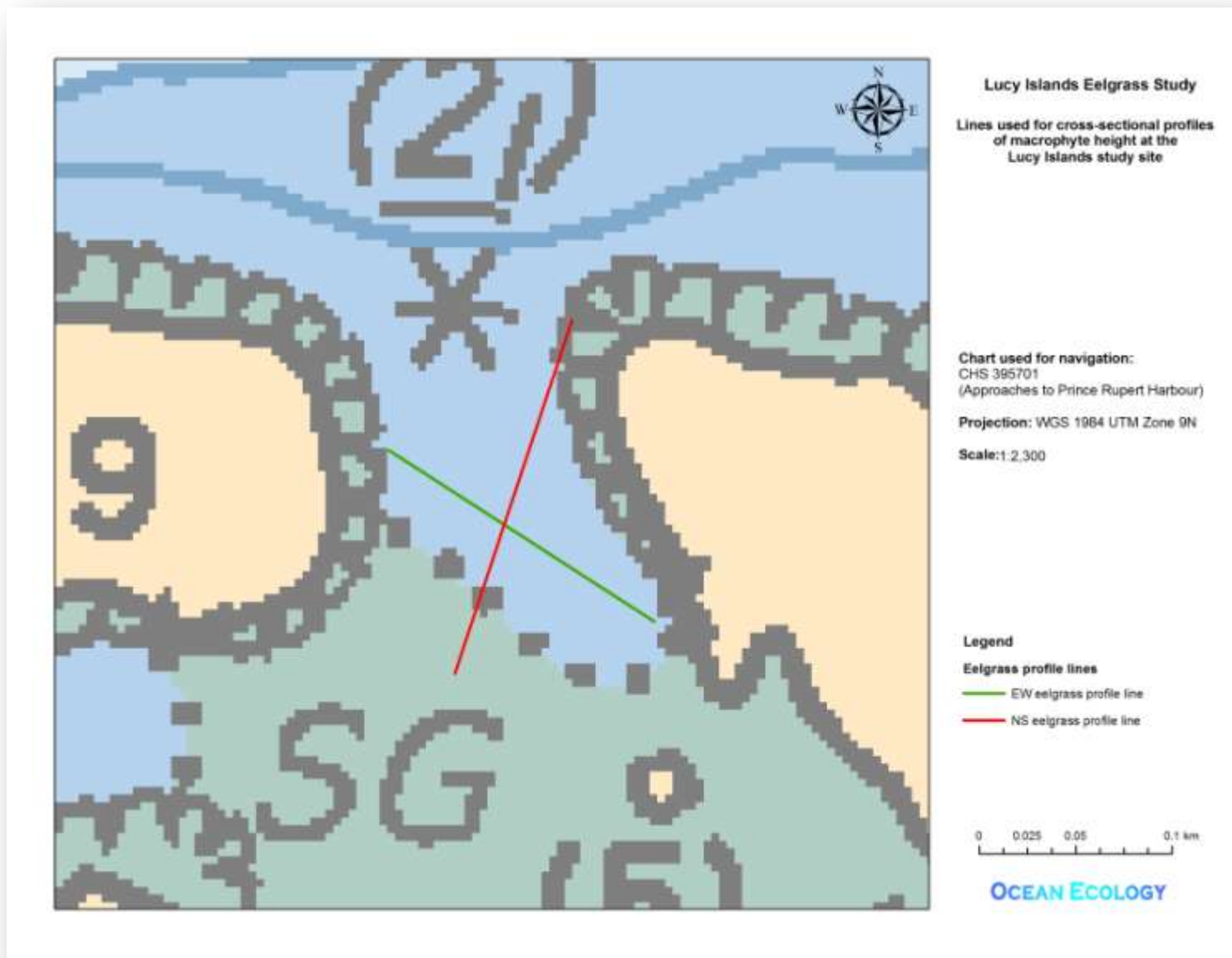

Figure 13. Lines used for cross-sectional profiles of macrophyte height at the Lucy Islands study site.

## 2.7 Multibeam Sonar Survey

### 2.7.1 Multibeam Sonar System

Multibeam sonar images were collected using a Humminbird 967c 3D sonar unit operating at 455 kHz. Simultaneously, the Humminbird unit also collected seafloor depth data using a downward-looking sonar operating at 83 kHz frequency. The transducer for the Humminbird unit is mounted in a towfish which was towed from the stern of the vessel at 2 m depth. Multibeam and downward-looking sonar data were recorded to an SD card in the proprietary Humminbird SON file format. The specifications of the multibeam sonar towfish and associated data collection system were:

- Specifications of downward-looking sonar:
  - 83 kHz beamwidth at -3dB = 52°
  - Transducer depth range: approximately 300 m
- Specifications of six multibeam sonar beams at 455 kHz:
  - Horizontal beamwidth at - 3dB = 11°
  - Vertical beamwidth at -3 dB = 11°
  - Transducer tilt angle from vertical = -22.1°, -13.3°, -4.4°, 4.4°, 13.3°, 22.1°
  - Transducer depth range: approximately 75 m
- Power output of unit: 1000 Watts (RMS)
- Swath width: 31.5 m in 30 m water depth and 2.1 m in 2 m water depth
- Positioning system: Electronic charting software using DGPS antenna mounted directly above the towfish

### 2.7.2 Survey Design

A single multibeam sonar survey was carried out on the eelgrass bed to the north of the sand bar. This survey occurred on July 17<sup>th</sup>, 2010 at high slack water. A series of north-south oriented transects were done (see Figure 14).

### 2.7.3 Processing of Multibeam Sonar Data

Multibeam sonar processing was performed by converting the raw multibeam sonar data files into a format which could be imported into MB-System ([http://www.mbari.org/data/mbsystem/html/mbsystem\\_home.html](http://www.mbari.org/data/mbsystem/html/mbsystem_home.html)), an open source image processing software developed by the Monterey Bay Aquarium Research Institute (MBARI) (Faggetter, 2010a, 2010e).

The processed multibeam sonar data was then used to generate a depth grid in Surfer and contour plots in ArcGIS as described for the single-beam sonar data processing in section 2.2.3 above.

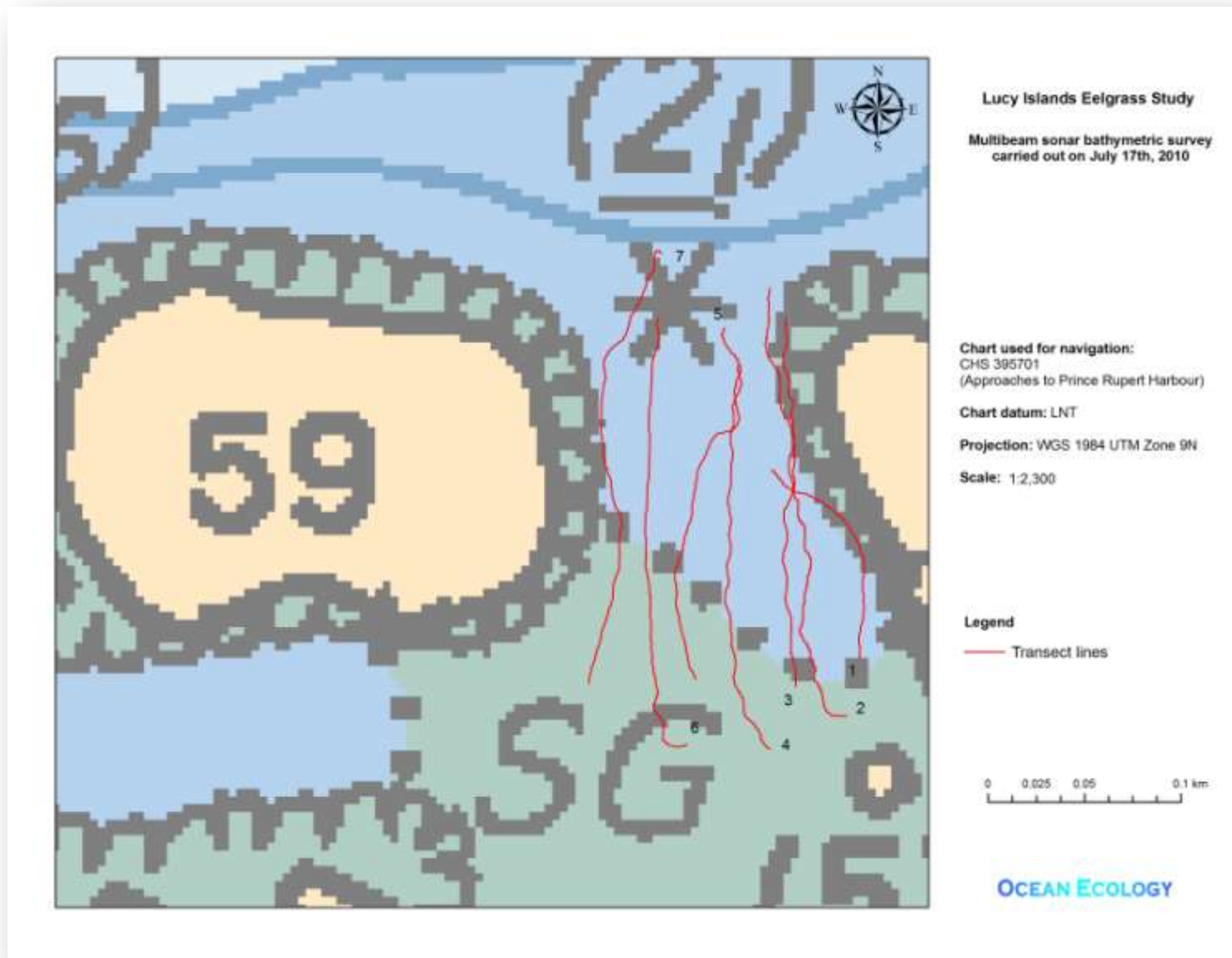

Figure 14. Multibeam sonar bathymetric survey carried out on July 17<sup>th</sup>, 2010.



## 2.8 Beach Seining

### 2.8.1 Survey Design

Beach seine surveys at the Lucy Islands were carried out using a 9.1 m (30') long by 1.2 m (48") deep minnow seine with a 0.32 cm (1/8") mesh. The method of deployment was a perpendicular quarter-arc set (see Figure 15). In this method, one person sets the seine straight out from shore until the end of the net or the deepest safe water is encountered. The end on shore is fixed, and the end away from shore is then pulled in a semicircle back to shore, keeping the net as elongated as possible. By using a fixed length of net and pulling the offshore end in a consistent manner, a consistent swept area can be attained. Beach seining was done at low tide on the north side of the sand bar located at the center of the study site. The seine net was set as far into the eelgrass bed as possible during each deployment.

The beach seine surveys were carried out on July 18<sup>th</sup>, 2010, October 27<sup>th</sup>, 2010, and April 20<sup>th</sup>, 2011. The net was set four times during the July survey, and three times during both the October and April survey.

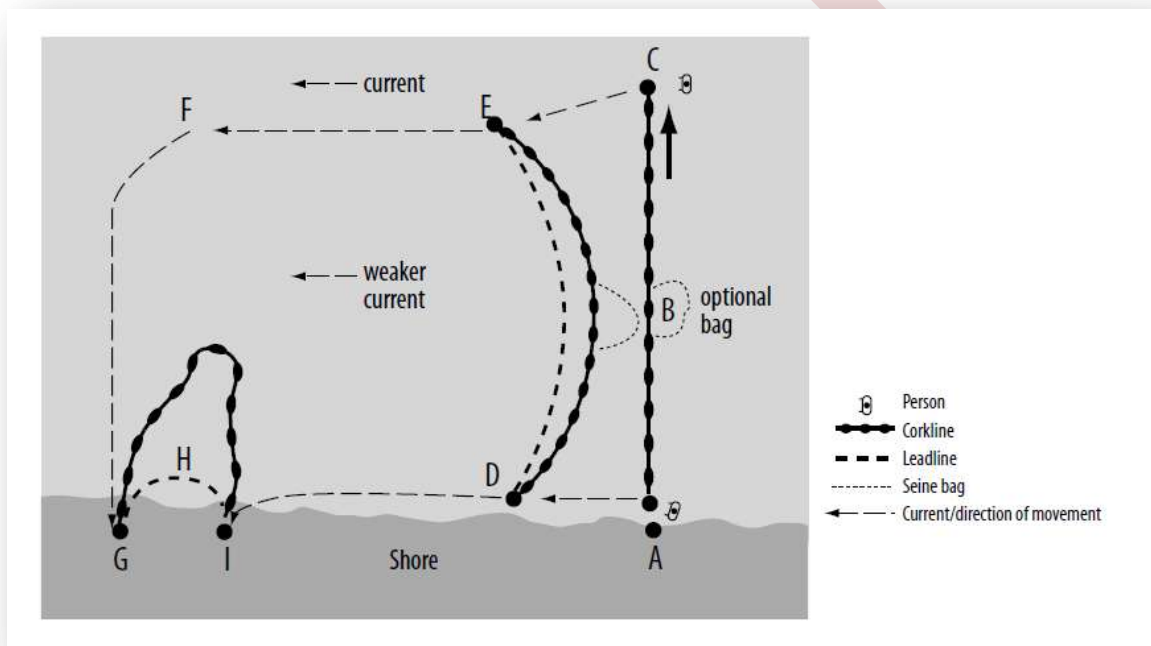

Figure 15. Perpendicular set deployment and retrieval of a beach seine (Hahn et al., 2008). If the person on the shore at A does not move to I, this becomes a perpendicular quarter-arc set.

### 2.8.2 Organism Identification

All fish and invertebrates caught in the beach seine were placed in a transparent fish viewer where they were measured, photographed using a 7.0 megapixel camera, and then released. Wherever possible, organisms were identified to species level.

## **2.9 Bird Observations**

During each field trip to the Lucy Islands study site, the birds present at the site were identified and enumerated.

## **2.10 Observations of Human Activities**

During each field trip to the Lucy Islands study site, the various human activities which were occurring at the site were noted.

Draft

### 3 Lucy Islands Eelgrass Study Results and Discussion

#### 3.1 Eelgrass Observations in the Upper Intertidal Zone

In addition to the lower intertidal and subtidal eelgrass (*Zostera marina*), which was the focus of the Lucy Islands study, a significant amount of eelgrass was observed in the upper intertidal zone (see Figure 16). This eelgrass had not been observed and recorded during the North Coast 2000 Aerial Video Imaging Survey of the region (CORI, 2000). There are several possible reasons for this:

1. The aerial survey of Lucy Islands was carried out at approximately 6:16 am on July 1<sup>st</sup>, 2000. At this time, the tide height was approximately 1.23 m. It was possible that the tide had not yet fallen sufficiently for the eelgrass bed to be exposed and visible at the low early morning sun angle.
2. Since maximum eelgrass biomass is reached in August I (Pedersen and Borum, 1993), it may have been that the July 1<sup>st</sup>, 2000 survey was still a bit too early in the year to capture the fullest extent of the Lucy Islands eelgrass beds.
3. The eelgrass bed may have expanded since 2000, and now occupies more of the intertidal zone than it once did.



Figure 16. Eelgrass in the upper intertidal zone at Lucy Islands exposed during low tide.



Figure 17. Exposed surfgrass in the upper intertidal zone at Lucy Islands.



Figure 18. Flowering head of *Zostera marina* at the Lucy Islands site.



Figure 19. Flowering head of *Phyllospadix scouleri* at the Lucy Islands site.

The intertidal eelgrass was not surveyed during the Lucy Islands study, and it is recommended that further intertidal survey work be carried out at the site. Accurate mapping of the intertidal regions of the eelgrass bed, along with a determination of the eelgrass height above LNT (Lowest Normal Tide), may assist in determining whether or not the eelgrass bed has expanded since 2000, or was simply missed during the aerial mapping as it is not high enough above LNT to be exposed at tidal heights of 1.23 m.

The intertidal eelgrass at the Lucy Islands site grew in mixed substrate (sand with cobbles and boulders, see Figure 16). As the upper limits of the intertidal zone were approached, the eelgrass became smaller and less abundant, possibly grading into the *Zostera marina typica* ecotype (primarily intertidal with low tolerance to current; has shorter, narrower blades; Precision Identification Biological Consultants, 2002). At the upper edge of the intertidal zone, as the eelgrass became less abundant, patches of surfgrass (*Phyllospadix scouleri*) started to appear (see Figure 17). In this transitional zone between eelgrass and surfgrass, differentiation between the two species became quite difficult, and often required finding the flowering heads (see Figure 18 and Figure 19). As a result of this, future surveys of the intertidal region of the Lucy Islands site should probably occur during the flowering season of both species (late spring to summer).

### **3.2 Single-beam Sonar Bathymetric Survey**

#### *3.2.1 Bathymetry*

Average tow speed during the bathymetric survey was 2.1 knots. A DGPS signal (positional accuracy between 0.5 and 5 m) was received throughout the survey. Observed depths ranged from -2.49 m (2.49 m above LNT) to 4.51 m (4.51 m below LNT). Much of the central region of the site on both sides of the sand bar would be exposed during a “zero” tide, and could technically be considered intertidal. However, as such extreme low tides are rare, only a small amount of the eelgrass bed at the site is normally exposed and visible during low tides. This probably explains why the eelgrass was not mapped during the North Coast 2000 Aerial Video Imaging Survey.

A large rock partially blocks the northern entrance to the site. This rock is marked on the CHS 395701 (Approaches Prince Rupert Harbour) chart, and should not pose a threat to navigation.

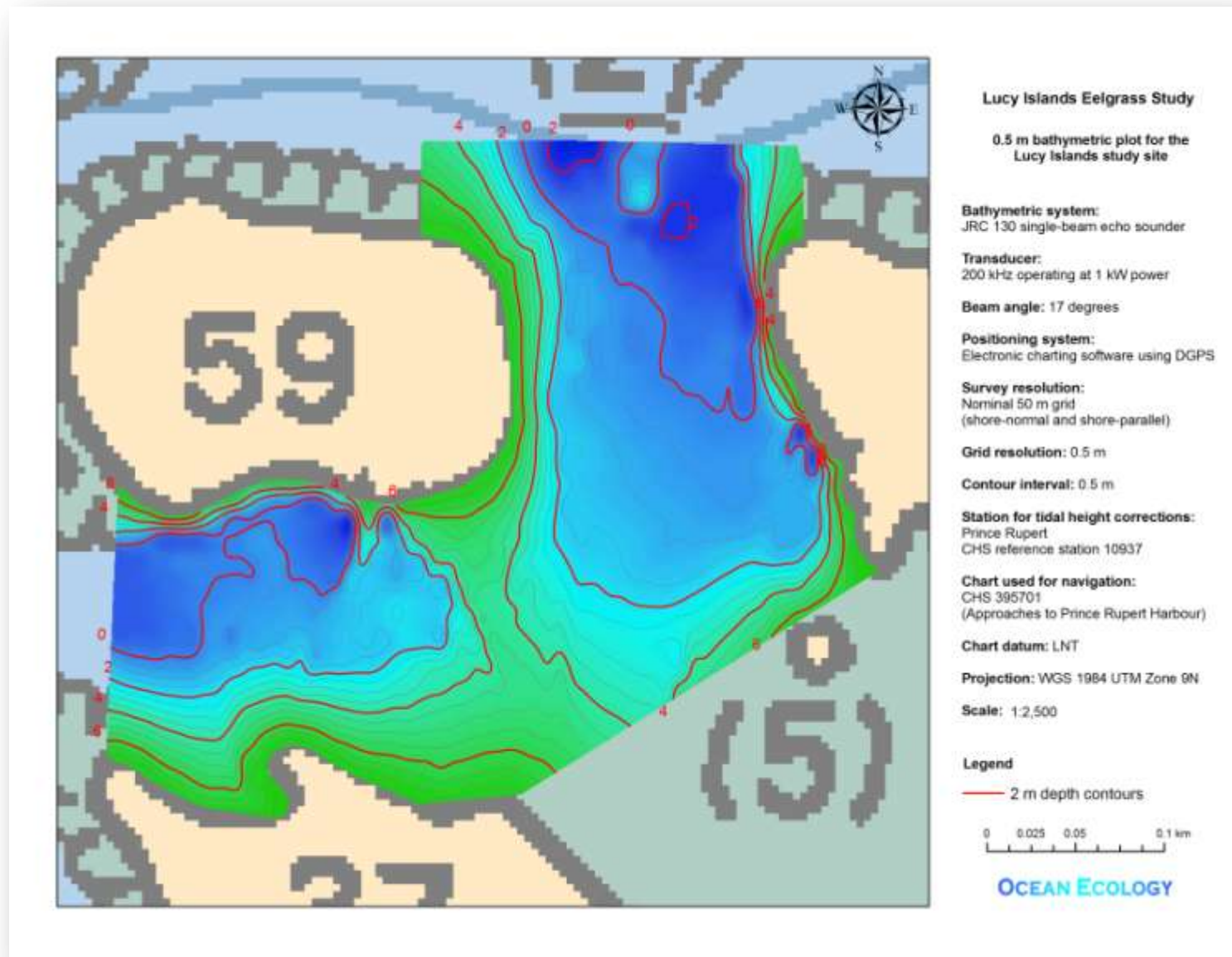

Figure 20. 0.5 m bathymetric plot for the Lucy Islands study site.

### **3.3 Benthic Video Survey**

#### *3.3.1 Substrate*

Overall, the main substrate at the Lucy Islands study site was sand. The central part of the site consisted of large stretches of sandy substrate with current-produced bedforms (mainly straight-crested current ripples). Closer to the islands on either side of the site, the substrate graded into sand mixed with pebbles, and ultimately to cobbles, boulders, and finally bedrock as the shoreline was reached.

Seasonal changes were observed in the substrate at the site (see Figure 21). On July 17<sup>th</sup>, 2010, sand had spread out from the center of the site, and was covering some of the pebbles and cobbles closer to the shore (see Figure 22). By October 27<sup>th</sup>, 2010, much of the sand near the shorelines had migrated (see Figure 23), leaving a bottom of “scoured” pebbles and small cobbles. Some of this scouring was still seen on April 20<sup>th</sup>, 2011 (see Figure 24); however, more sand was present around the north end of the site than during October, indicating that sand was starting to migrate back towards the sandbar between the two islands.



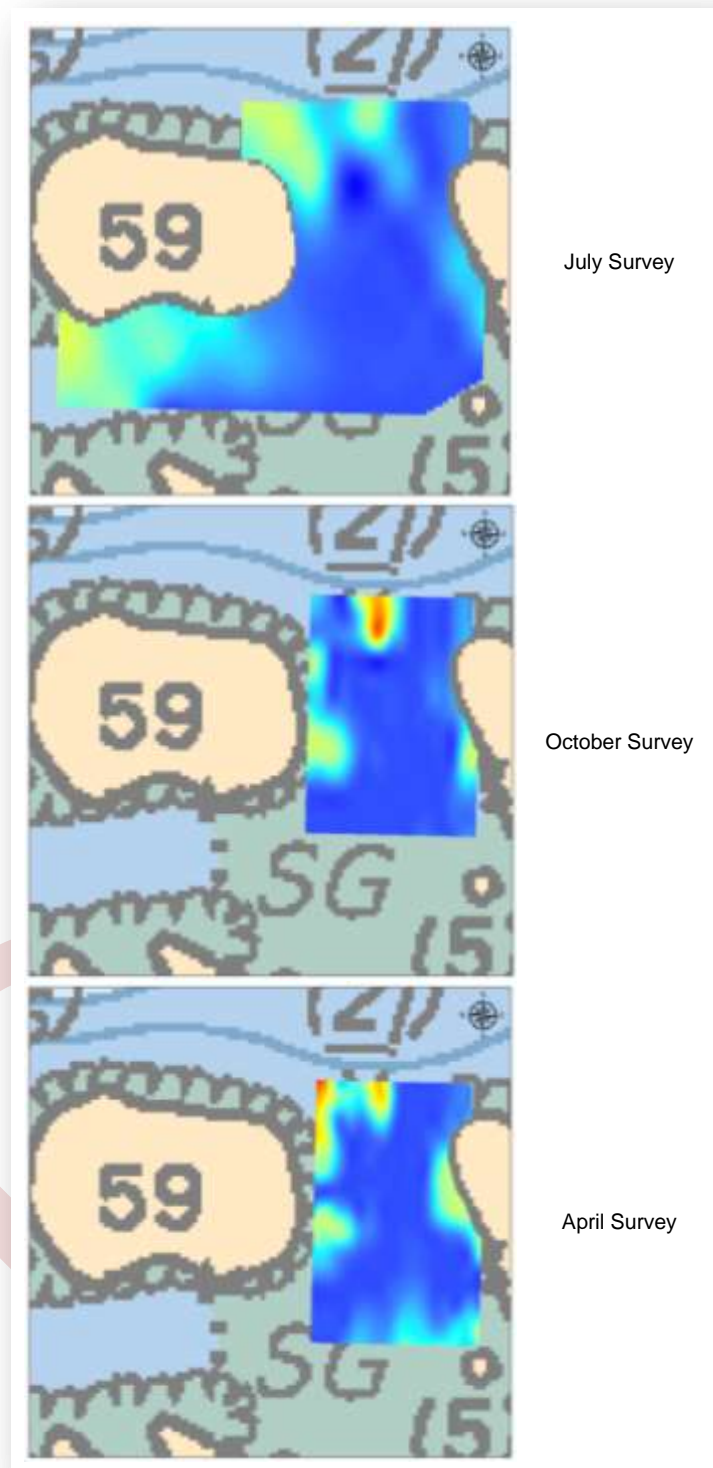

Figure 21. Overview of the temporal changes in substrate particle size at the Lucy Islands study site.

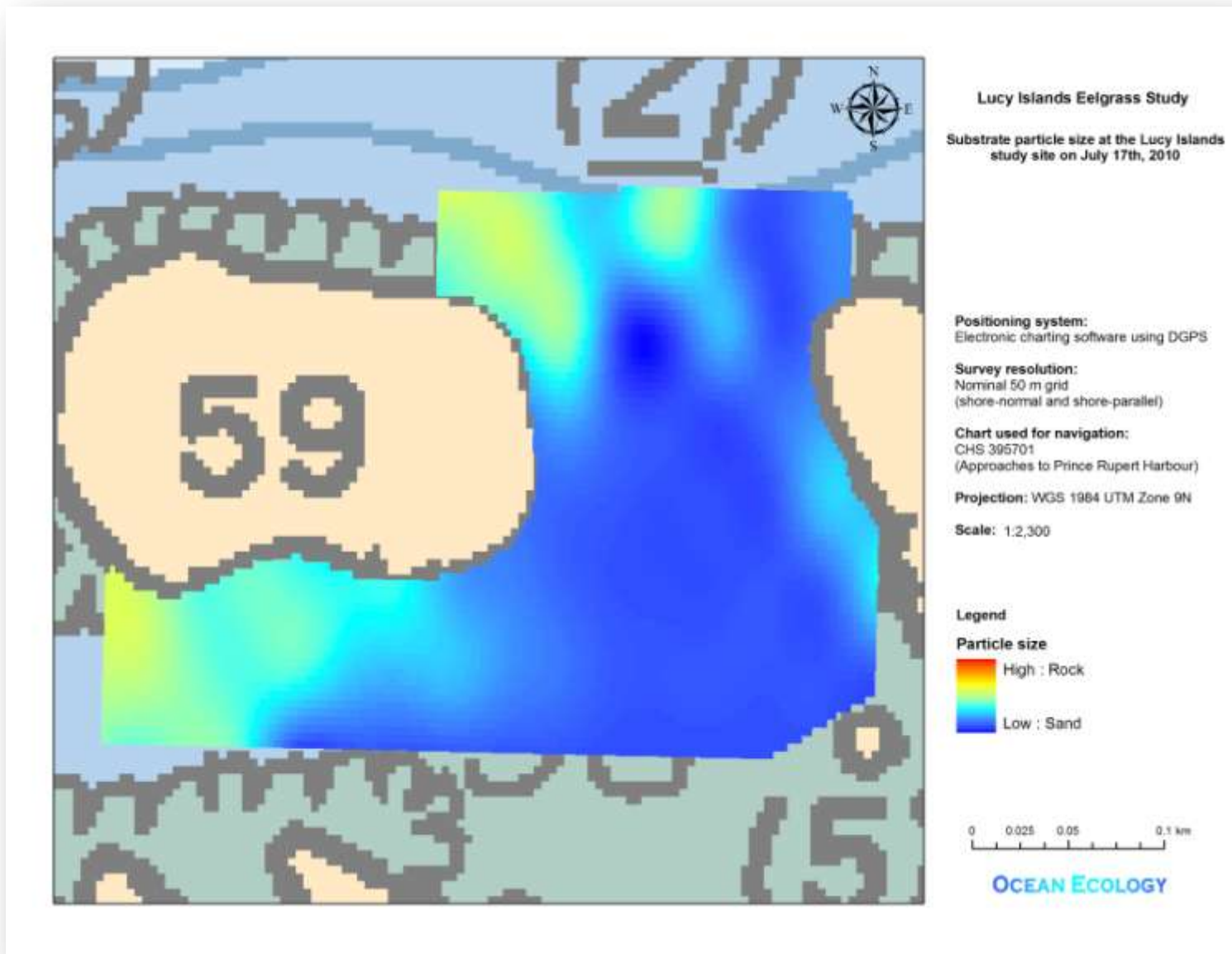

Figure 22. Substrate particle size at the Lucy Islands study site on July 17<sup>th</sup>, 2010.

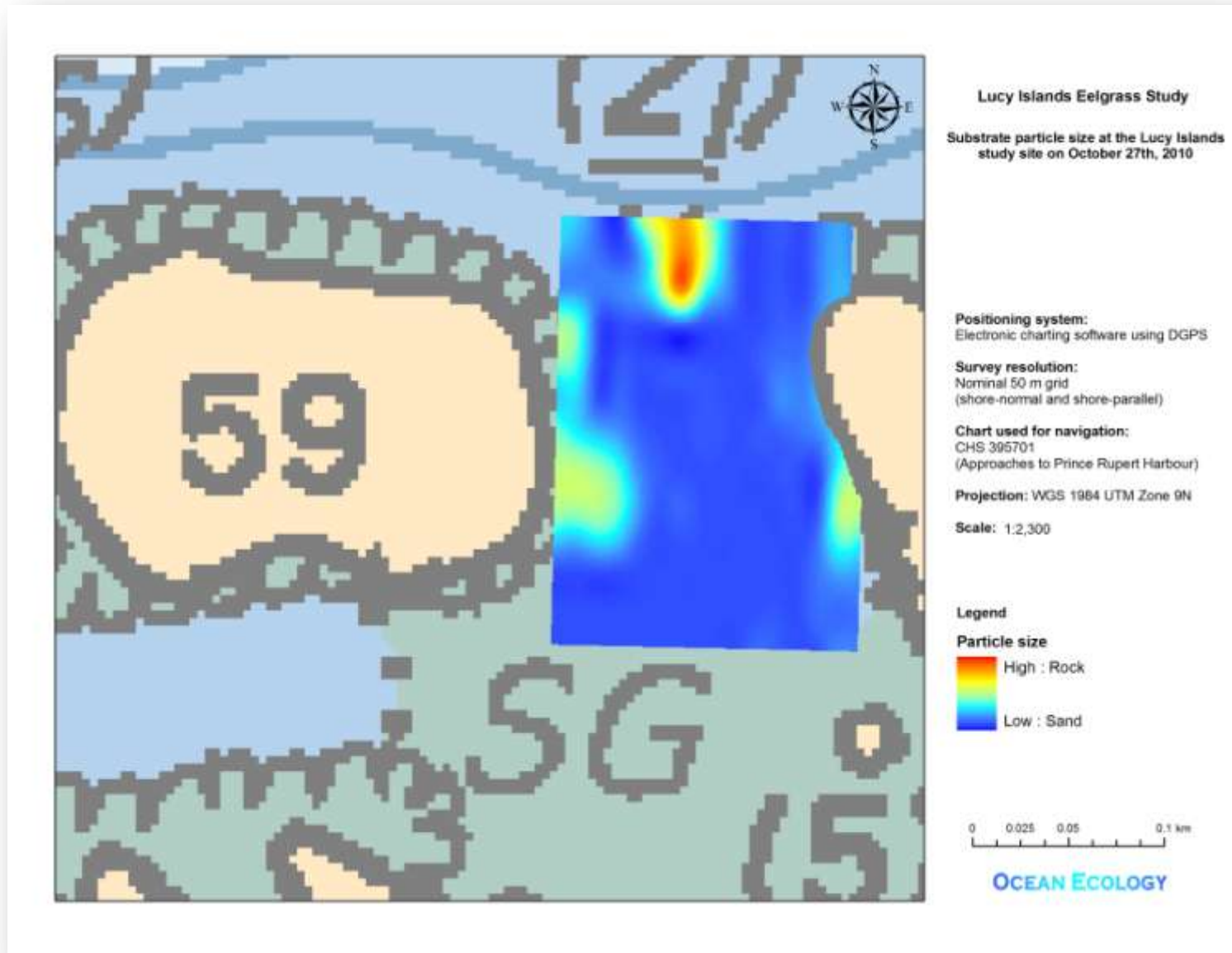

Figure 23. Substrate particle size at the Lucy Islands study site on October 27<sup>th</sup>, 2010.

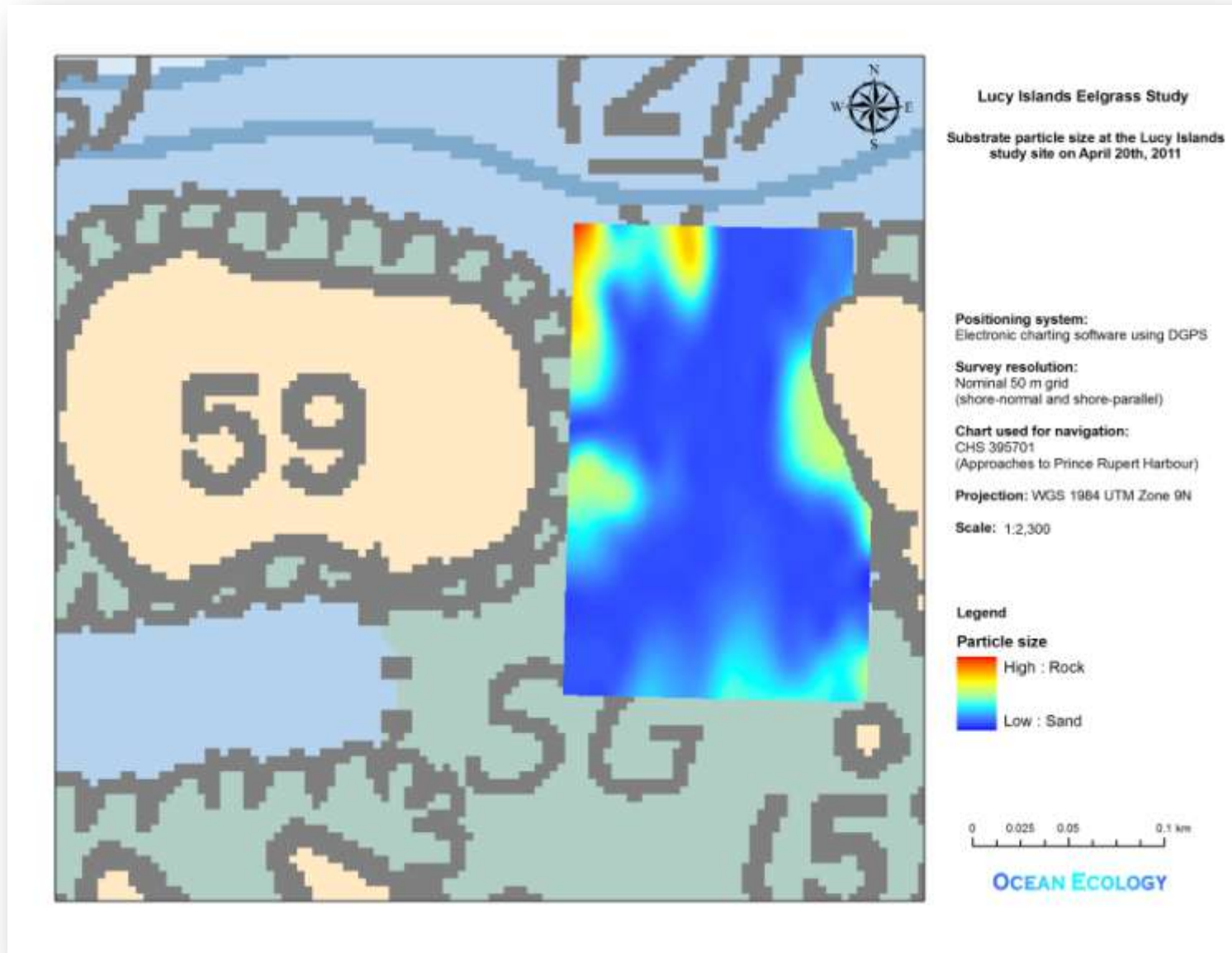

Figure 24. Substrate particle size at the Lucy Islands study site on April 20<sup>th</sup>, 2011.

### 3.3.2 Flora

#### 3.3.2.1 Algae

Algae were widely distributed at the Lucy Islands site. Due to the presence of small amounts of pebble and cobble throughout the site, which acted as attachment sites for algal holdfasts, most algae species had broad patterns of distribution across the site rather than localized areas of abundance. Some of the observed trends were:

- Foliose greens were the dominant algae at the site during the July and April surveys. During the October survey, the dominant alga was sugar wrack kelp (*Laminaria saccharina*).
- Foliose reds were significantly more abundant during the April survey than during the other two surveys.
- Coralline reds were associated with bare exposed bedrock and boulder surfaces. They were frequently found in areas with high sea urchin populations, where intense sea urchin grazing had created “urchin barrens”. In these regions, only coralline red algae, with their calcified cell walls, can survive.
- Filamentous greens were found primarily in the shallow water regions on North side of site.
- Kelp species tended to be more abundant in rockier substrates, but were also found attached to small pebbles in the sandier parts of the site.
- The dominant kelp species at the site was sugar wrack kelp (*Laminaria saccharina*).

Algal abundance and diversity varied seasonally (see Table 1). This can be best described by comparing the changes seen at the north side of the site over the course of the three surveys. July and April had similar species richness (12 and 13 species, respectively), whereas October had a significant decline in the number of species present (5 species), which was seen most markedly in the total absence of green algae. Algal abundance was greatest in July, declined significantly in October, and then started to increase again in April. This decline in algal abundance and diversity in the late fall is probably due to two factors: (1) algal growth during the late fall and winter tends to be light limited; and (2) fall storm activity would have torn loose much of the algae produced during the summer season.

Table 1. Algal abundance and diversity at the north side of the Lucy Islands site.

Species	July 2010 survey number of observations	October 2010 survey number of observations	April 2011 survey number of observations
Alaria	68		142
Coralline reds	46	146	19
Filamentous greens	14		27
Filamentous reds	197	36	135
Foliose greens	982		584
Foliose reds	88	13	260
Fucus	10		
Fringed sea colander kelp			2
Nereocystis	8		16
Red fringe	13		149
Seersucker kelp	4		18
Split kelp			79
Sugar wrack kelp	803	676	483
Three-ribbed kelp	8	2	8
<b>Total observations</b>	<b>811</b>	<b>678</b>	<b>755</b>
<b>Total species</b>	<b>12</b>	<b>5</b>	<b>13</b>

### 3.3.2.2 Eelgrass

The eelgrass abundance, both in terms of number of observations and areal coverage, for the north side of the Lucy Islands site is given in Table 2. The July survey had the greatest eelgrass abundance. By October, a significant decline was seen in both the number of observations and the areal cover. Unlike the algae, which were already showing increasing abundance by April, the eelgrass was still in decline in April. It appears that the maximum growth for eelgrass is somewhat later in the season than for algae. This observation is supported by previous research. A study on the growth and nitrogen uptake by eelgrass in a homogeneous bed located in the Oresund approximately 10 km north of Copenhagen (latitude 55° 40' N) showed that maximum eelgrass biomass was reached in August and minimum biomass was found in April (Pedersen and Borum, 1993). While this study took place in the Atlantic, it was at a similar latitude to Prince Rupert (54° 19' N), and thus probably reflects the seasonal patterns observed here. By contrast, a study on the dark brown wrack kelp (*Laminaria groenlandica*) on the west coast of Vancouver Island showed that peak blade elongation occurred during April and May (Druehl and Cabot, 1987). A second study showed that percentage cover of macroalgae at Grays Harbor Estuary, Washington, increased dramatically between February and April (Thom, 1984).

Table 2. Eelgrass abundance at the north side of the Lucy Islands site.

Parameter	July 2010 survey	October 2010 survey	April 2011 survey
Number of observations	2,168	1,794	1,632
Areal cover (m <sup>2</sup> )	39,653	34,650	34,274

The density distributions of eelgrass as observed during the three surveys are shown in Figure 26 (July), Figure 27 (October), and Figure 28 (April).

In the July survey, two regions of the site were surveyed:

- North of the sandbar. Eelgrass density was greatest in two locations: (1) on the west side (the largest concentration of eelgrass); and (2) on the east side (a smaller patch of eelgrass).
- West of the sandbar. A single small region of high eelgrass density was located mid-channel.

Overall, the region to the north of the sandbar had a higher density of eelgrass than the region to the west of the sandbar.

Temporal variations in eelgrass density can be observed by comparing the density distribution for the north region over all three surveys (see Figure 25). This can be done by examining the area of the region encompassed by the 50% expected population contour (red contour line in the figures; this is the region which is expected to contain 50% of the eelgrass population):

- July survey (Figure 26) - 15,227 m<sup>2</sup> total area within the 50% expected population contour divided into two subregions (12,267 m<sup>2</sup> and 2,960 m<sup>2</sup>).
- October survey (Figure 27) - 10,351 m<sup>2</sup> total area within the 50% expected population contour in a single bilobed region.
- April survey (Figure 28) - 10,623 m<sup>2</sup> total area within the 50% expected population contour divided into two subregions (8,688 m<sup>2</sup> and 1,935 m<sup>2</sup>).

The eelgrass bed at the Lucy Islands study site was at its largest extent during the July survey. By October, the bed had declined to 68% of its former extent, with the greatest decline in the eastern subregion. A slight increase in eelgrass density was observed during the April survey, with the eastern subregion beginning show increasing eelgrass population.

In all three surveys, the central channel of the north region showed lower eelgrass density than along the sides of the channel.

The percentage eelgrass cover as observed during the three surveys is shown in Figure 30 (July), Figure 31 (October), and Figure 32 (April).

In the July survey, two regions of the site were surveyed:

- North of the sandbar. Eelgrass percentage cover was greatest along the sides of the channel and lowest in the center of the channel.
- West of the sandbar. Eelgrass percentage cover was roughly constant throughout the region.

Again, temporal variations in eelgrass percentage cover can be observed by comparing the percentage cover for the north region over all three surveys (see Figure 29).

- July survey (Figure 30) - Eelgrass cover is greatest on the west side of the channel and somewhat lower on the east side. There is a central region of low eelgrass cover.
- October survey (Figure 31) - The central region of low eelgrass cover has widened, and the percentage cover in this region is further reduced from the July survey.
- April survey (Figure 32) - While the percentage cover is not as high as for the July survey, there is an indication that the eelgrass is spreading out back into the central region.

A possible explanation of these observations is as follows. There is seasonal sand migration at the site, from offshore sandbars in the winter to the sandbar at the middle of the study site in the summer (see section 3.5.5). This sand movement occurs along the center of the channel where currents are the strongest. During the offshore movement of sand in the winter, some of the eelgrass plants in the center of the channel may become uprooted. Uprooting and loss of eelgrass rhizomes would be aggravated in shallow areas when a low tide event coincided with an intense winter storm. Under these circumstances, the erosional effects of waves on the sea floor can be very significant, and probably some plants in these areas would not survive. Additionally, throughout the site, the eelgrass plants cease to grow as they become light-limited in the winter, and winter storms erode their remaining leaves, thus reducing the overall eelgrass percentage cover. Eelgrass plants located along the sides of the channel are better protected from storm waves and strong currents, and thus experience less erosion and uprooting. The greater amount of cobbles and boulders along the sides of the channel help to stabilize the sand, thus preventing it from migrating offshore in the winter, and reducing the impact of sand mobility on the eelgrass in these regions. During the summer, sand moves back into the site, and currents become lower. The eelgrass begins to grow again as the light levels increase, and some recolonization of the central channel takes place.



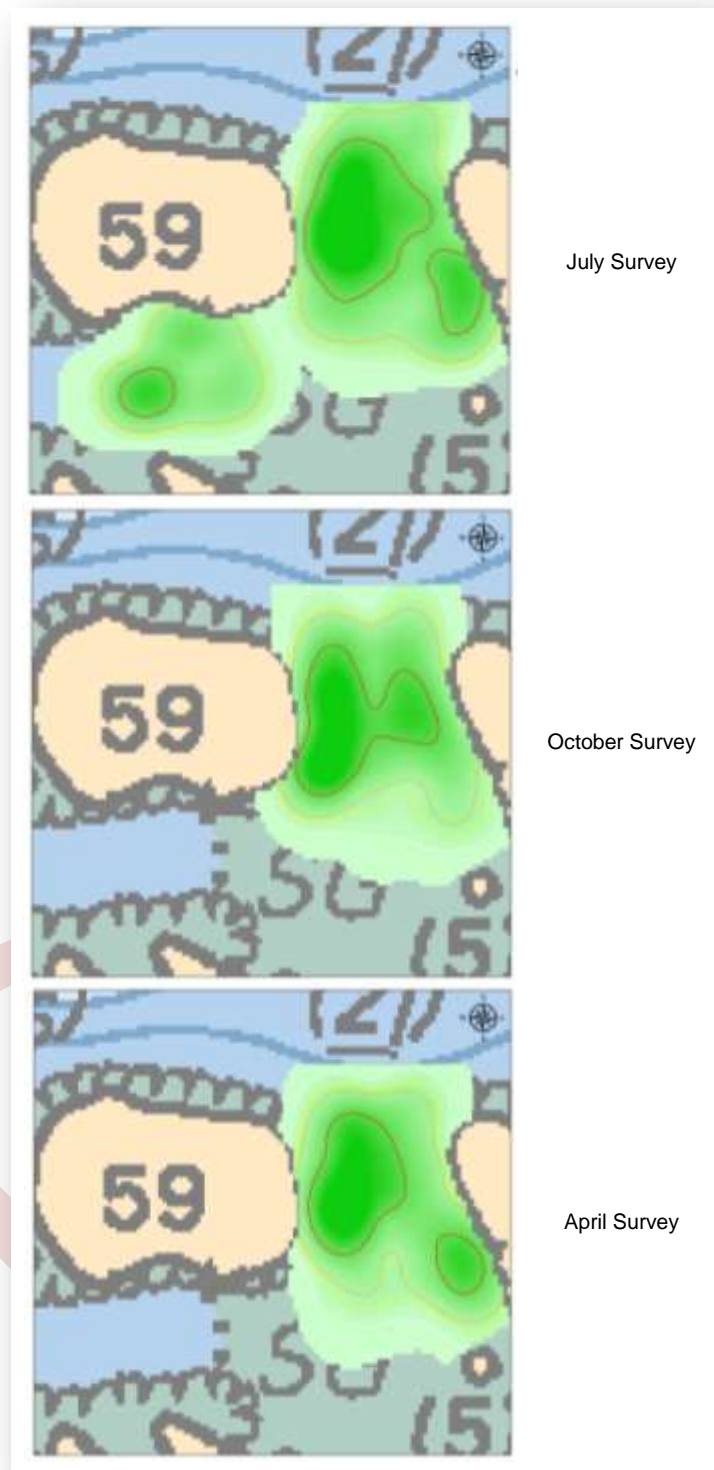

Figure 25. Overview of the temporal changes in eelgrass density at the Lucy Islands study site.



Figure 26. Density map for eelgrass at the Lucy Islands study site on July 17<sup>th</sup>, 2010.

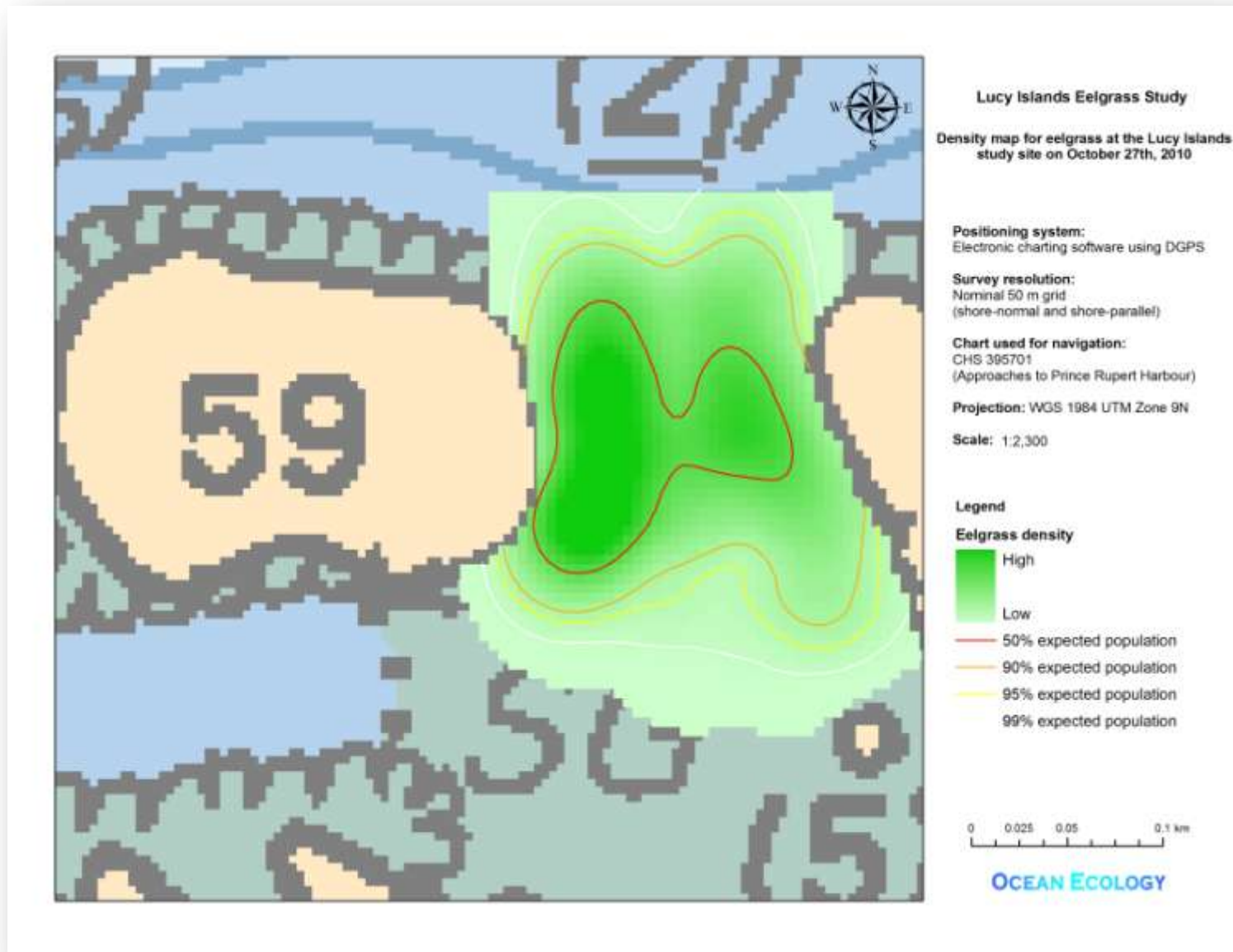

Figure 27. Density map for eelgrass at the Lucy Islands study site on October 27<sup>th</sup>, 2010.



Figure 28. Density map for eelgrass at the Lucy Islands study site on April 20<sup>th</sup>, 2011.

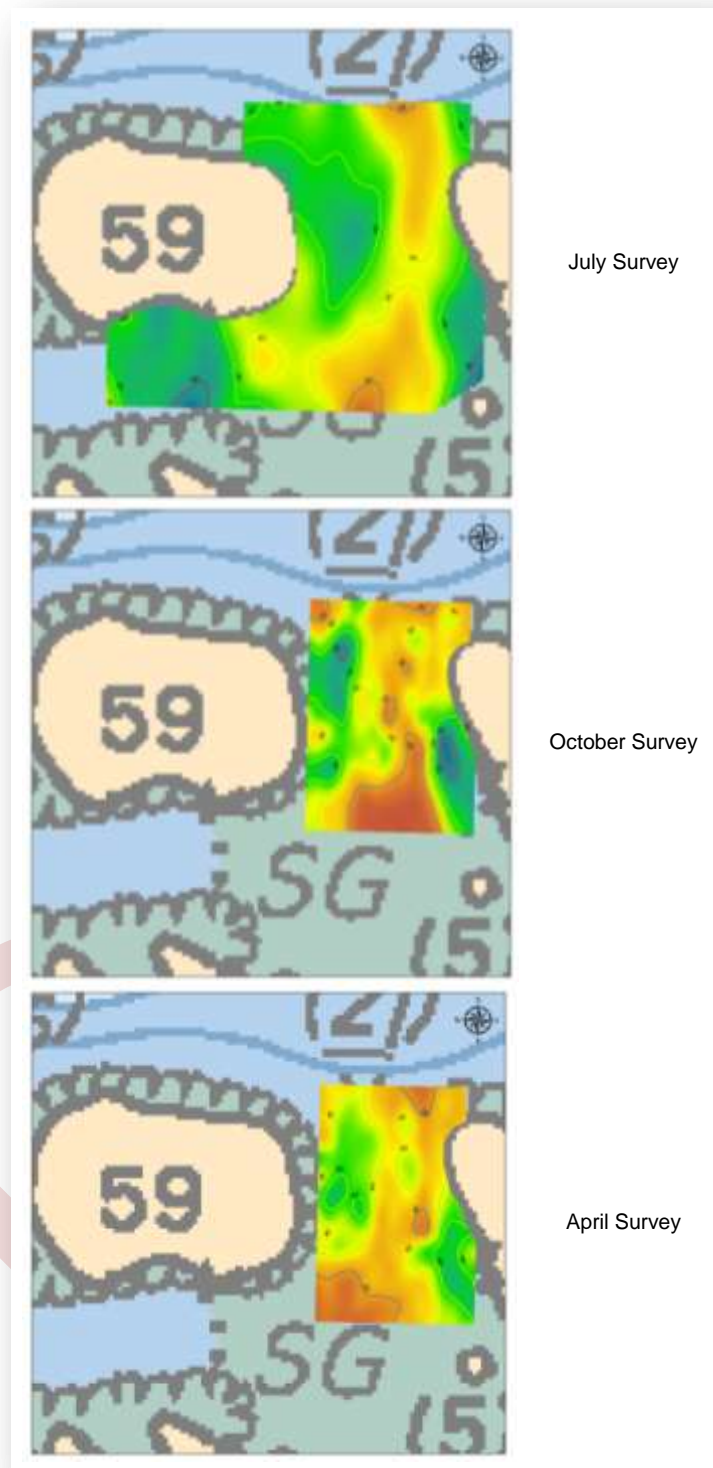

Figure 29. Overview of the temporal changes in eelgrass cover at the Lucy Islands study site.

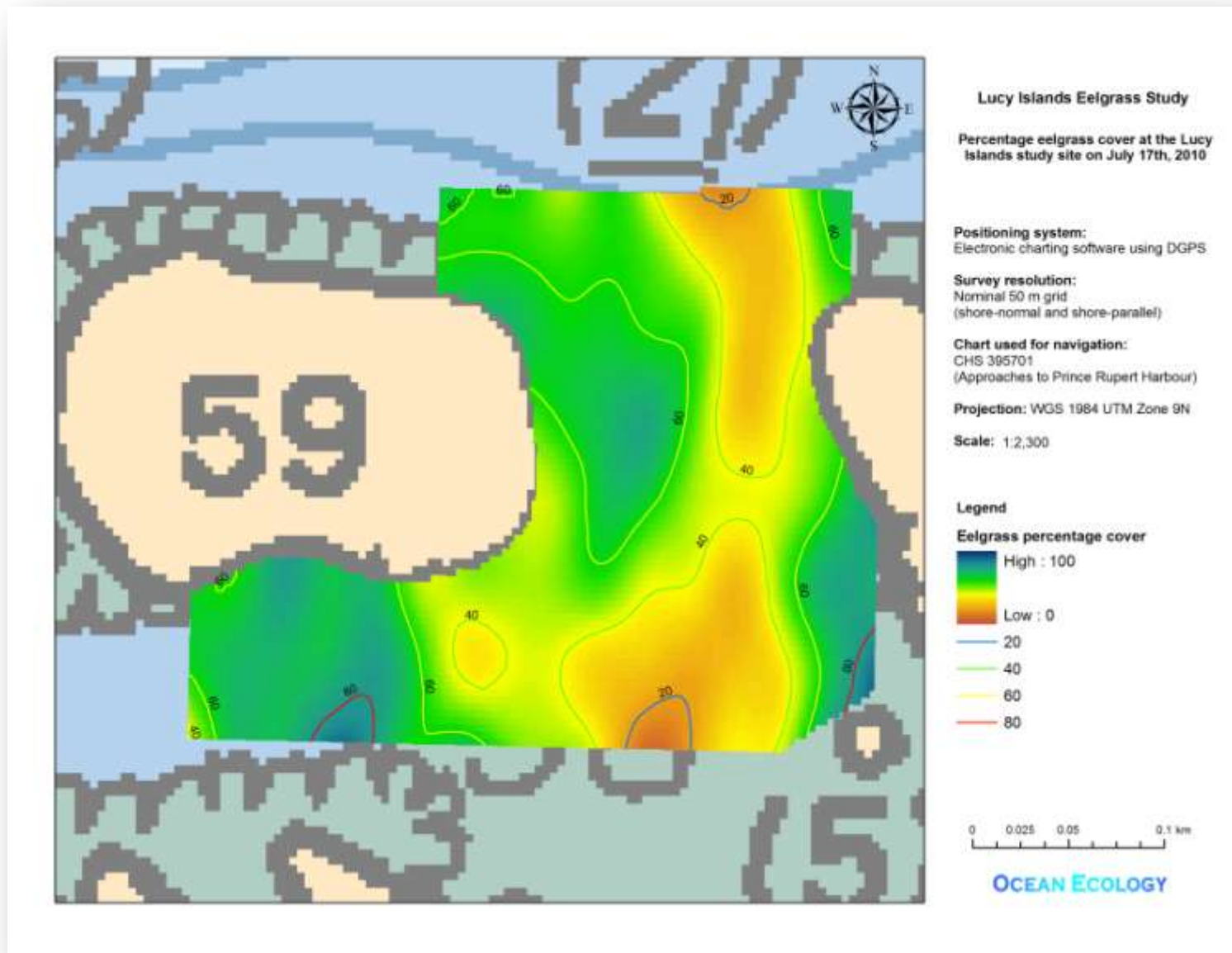

Figure 30. Percentage eelgrass cover at the Lucy Islands study site on July 17<sup>th</sup>, 2010.

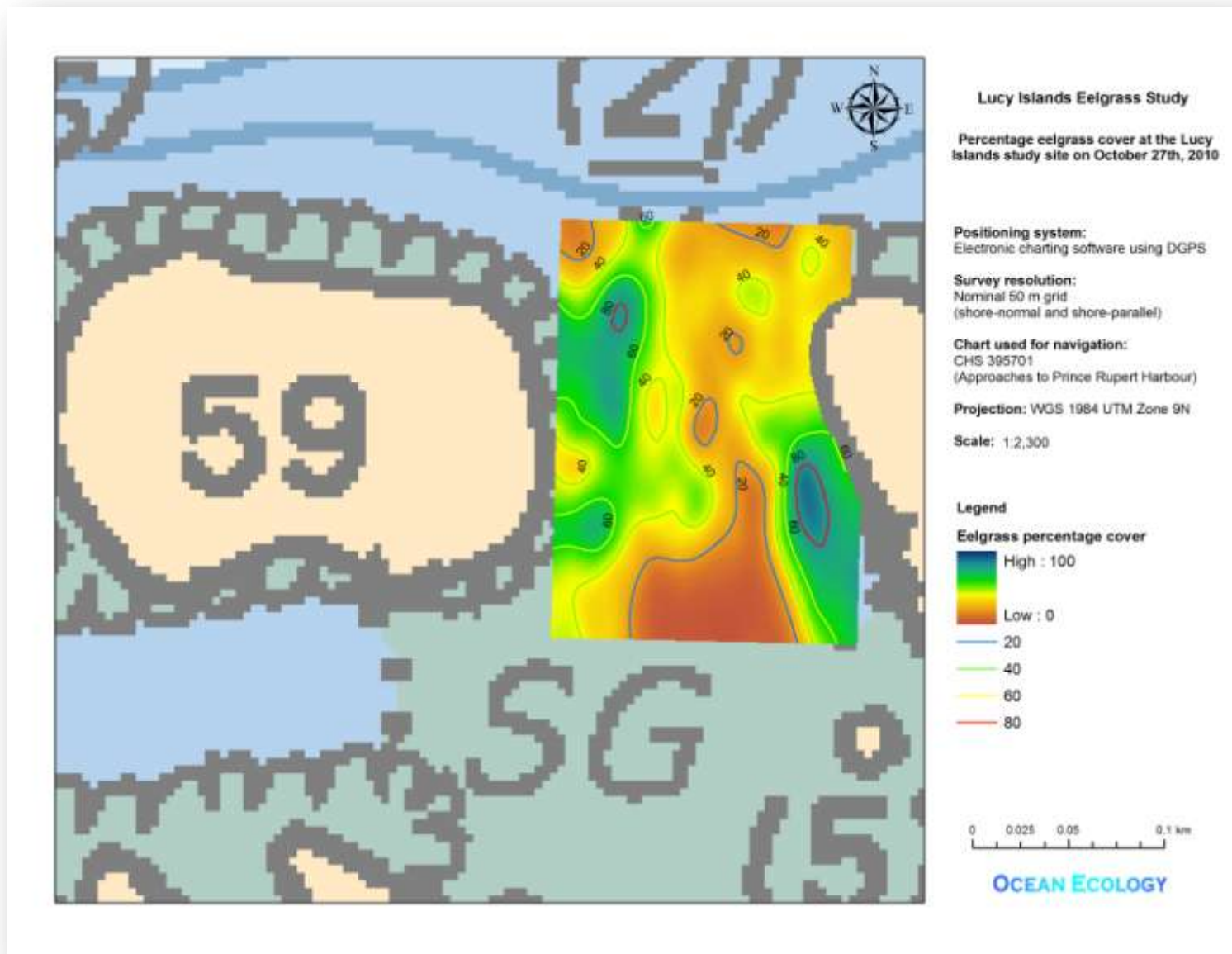

Figure 31. Percentage eelgrass cover at the Lucy Islands study site on October 27<sup>th</sup>, 2010.

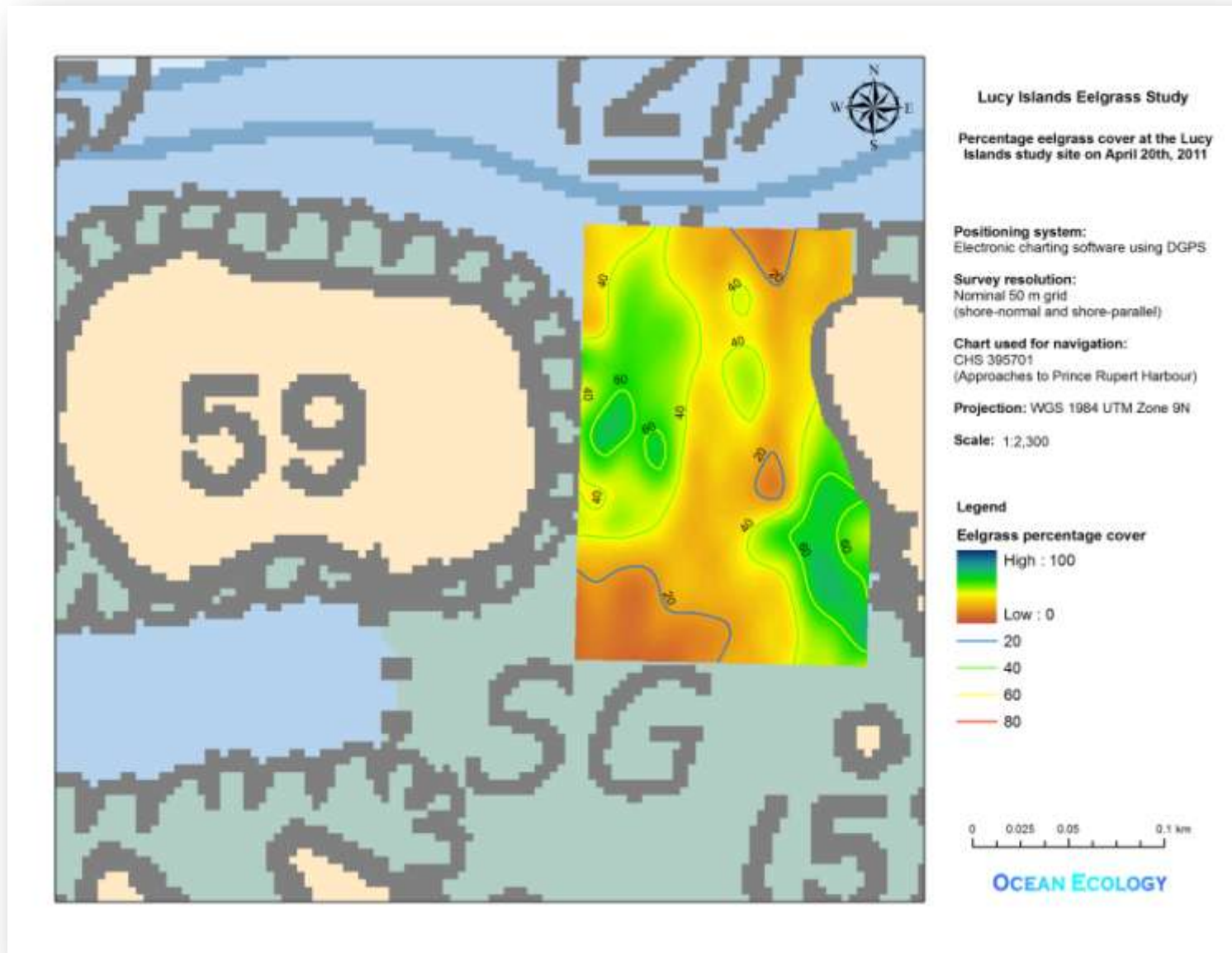

Figure 32. Percentage eelgrass cover at the Lucy Islands study site on April 20<sup>th</sup>, 2011.



### 3.3.3 Fauna

The distribution of fauna at the Lucy Islands study site is shown in Figure 33 (July), Figure 34 (October), and Figure 35 (April). Symbol types represented different faunal phyla as follows:

- ☼ - Phylum Cnidaria
- ⊕ - Phylum Mollusca
- ⬡ - Phylum Arthropoda
- ☆ - Phylum Echinodermata
- ◇ - Phylum Chordata
- ○ - Unidentified Phylum

Faunal abundance and diversity are shown Table 3. Fauna varied both spatially within the study site and temporally between the site surveys. The following observations were made:

- The total number of species observed was highest during the July survey and lowest during the April survey.
- The numbers of observations of several species (purple sea urchin, red sea urchin, horseclam, geoduck clam, and unrounded holes) were quite high in the April survey. Although this may be due to an actual increase in population numbers, it may also be due in part to the decreased abundance of flora, which makes these organisms more visible and easier to count.
- Purple and red sea urchins were very abundant during all three surveys, and were largely found in the region around the rock at the north entrance to the site.
- Eelgrass limpets were abundant during the July survey, but were not observed during the other surveys. While they may have been present at other times of the year (they are somewhat cryptic and not always easy to identify), they were clearly more abundant during July.
- In general, fish were most abundant during the July survey. Kelp greenlings were present in the July and October survey, but not the April survey. Shiner perch and starry flounders were present mainly during the July survey.
- Schools of unidentified juvenile salmonids were present only during the October survey. Most juvenile salmonids have left the nearshore environment by September; however, some chinook fingerling smolts (60 - 80 mm in length) may be present in the nearshore from July through to November (Beamish *et al.*, 2003). These fish may well have originated from the Skeena River, and are sheltering in the eelgrass beds of the outer islands on their seaward migration.
- Dungeness crabs were present in the July and October survey, but not the April survey. This agrees with previous studies on Dungeness crab migration. Dungeness crabs generally inhabit deeper waters between November and April, and only reappear in shallow water in late April (Stone and O'Clair, 2001).
- Moon snail egg cases (listed as "Other" in Table 3) were most abundant during the July survey, and absent during the April survey.

Table 3. Faunal abundance and diversity at the north side of the Lucy Islands site.

Species	July 2010 survey number of observations	October 2010 survey number of observations	April 2011 survey number of observations
Decorator crab	1		
Dungeness crab	2	4	
Eelgrass limpet	28		
False ochre seastar			1
Geoduck clam	9		53
Giant green anemone			1
Green sea urchin		12	9
Helmet crab		2	
Horseclam	3		13
Kelp crab	2		
Kelp greenling	2	2	
Leather star			2
Moon snail		2	
Mounded hole	1		2
Nuttall's cockle	7	2	7
Ochre seastar	2	1	1
Orange sea pen			2
Other	6	2	
Plumose anemone		2	
Purple sea urchin	79	63	191
Red sea cucumber			8
Red sea urchin	69	70	185
Rose star	1		
Shiner perch	8	2	
Solaster sp.			1
Starry flounder	7		
Sunflower seastar	4	2	
Tubesnout		4	
Unidentified fish	1		
Unidentified salmonid		54	
Unidentified seastar		1	
Unmounded hole	18	50	342
Urticina sp.	8	9	5
<b>Total observations</b>	<b>26</b>	<b>114</b>	<b>347</b>
<b>Total species</b>	<b>20</b>	<b>18</b>	<b>16</b>

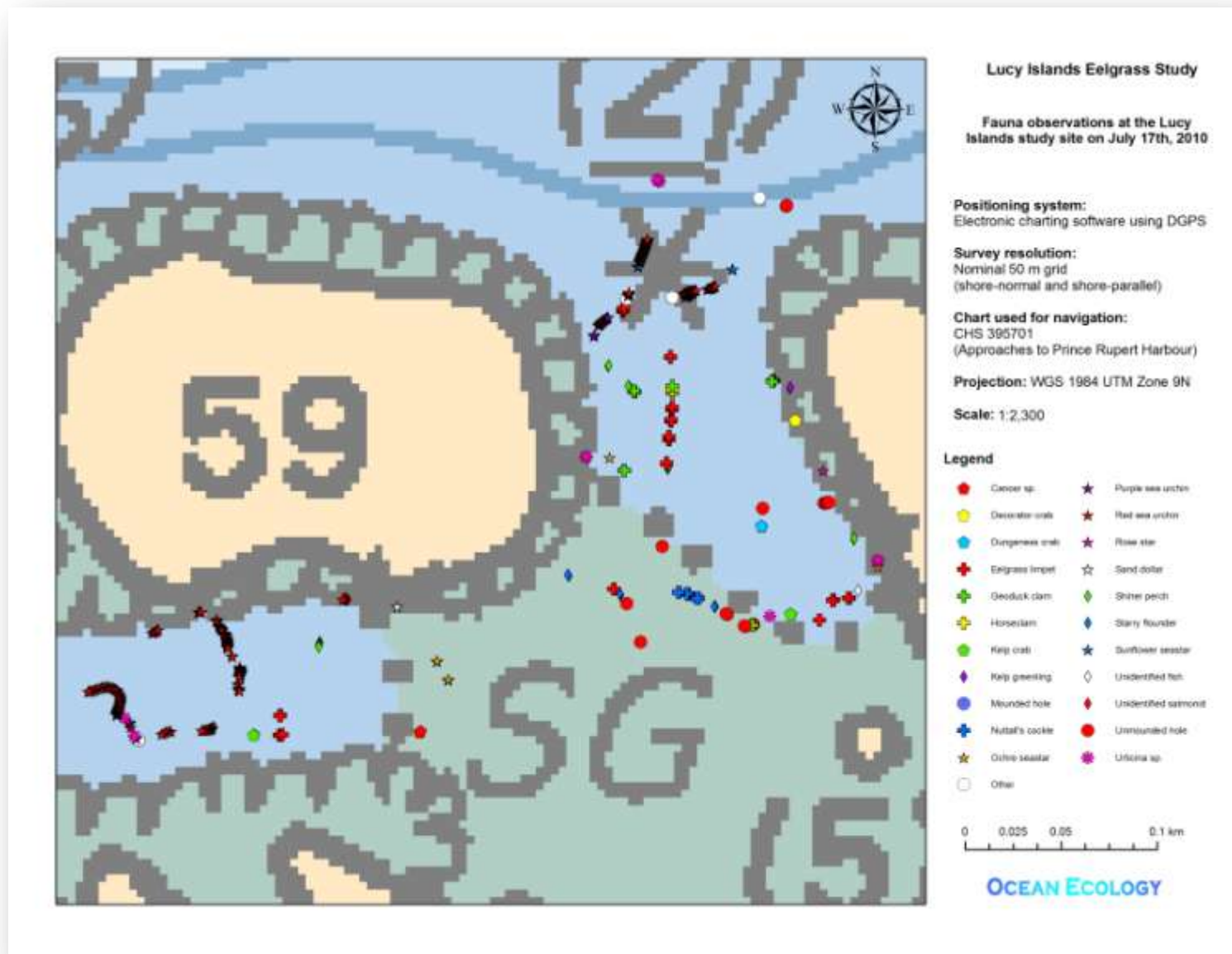

Figure 33. Fauna observations at the Lucy Islands study site on July 17<sup>th</sup>, 2010.

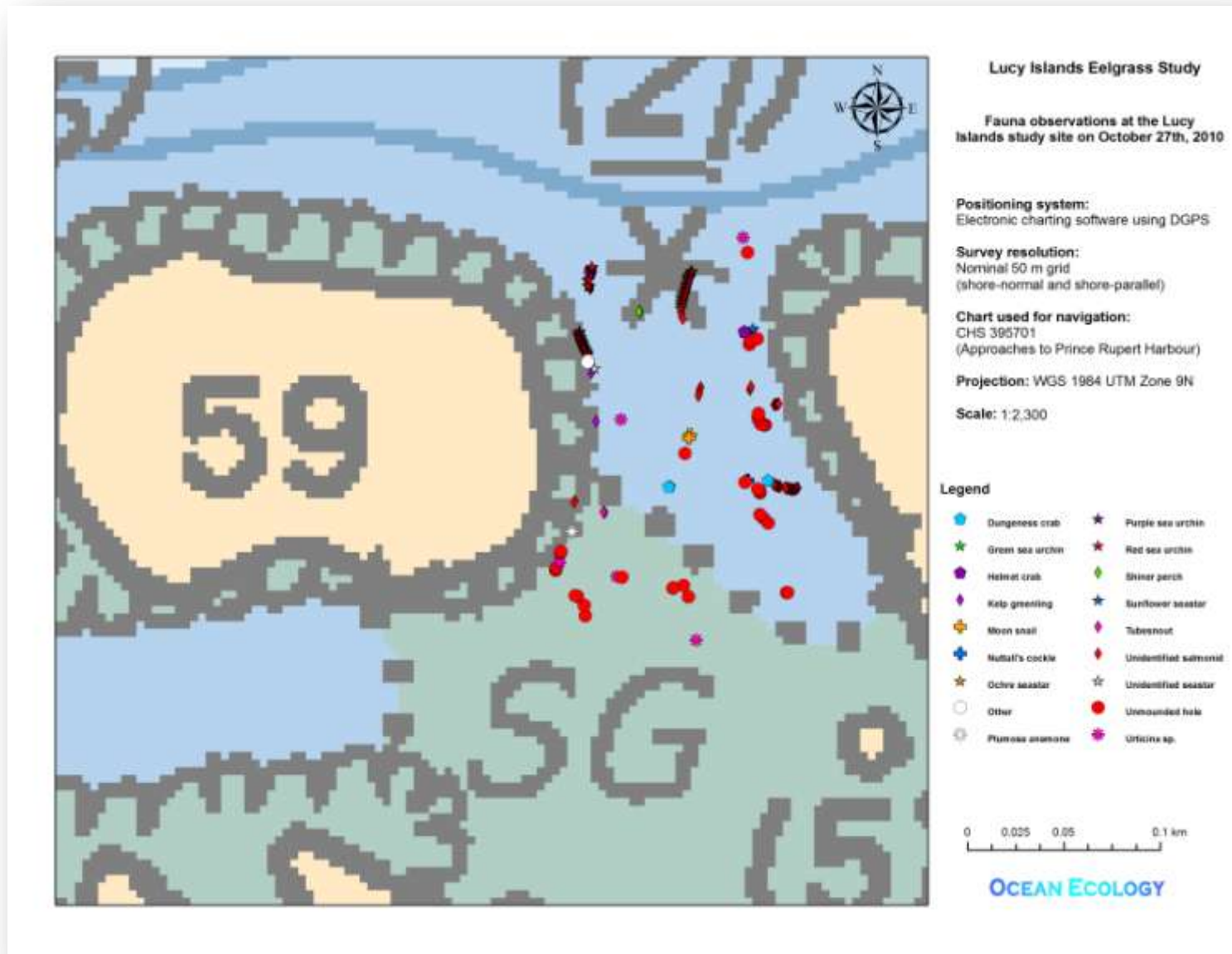

Figure 34. Fauna observations at the Lucy Islands study site on October 27<sup>th</sup>, 2010.

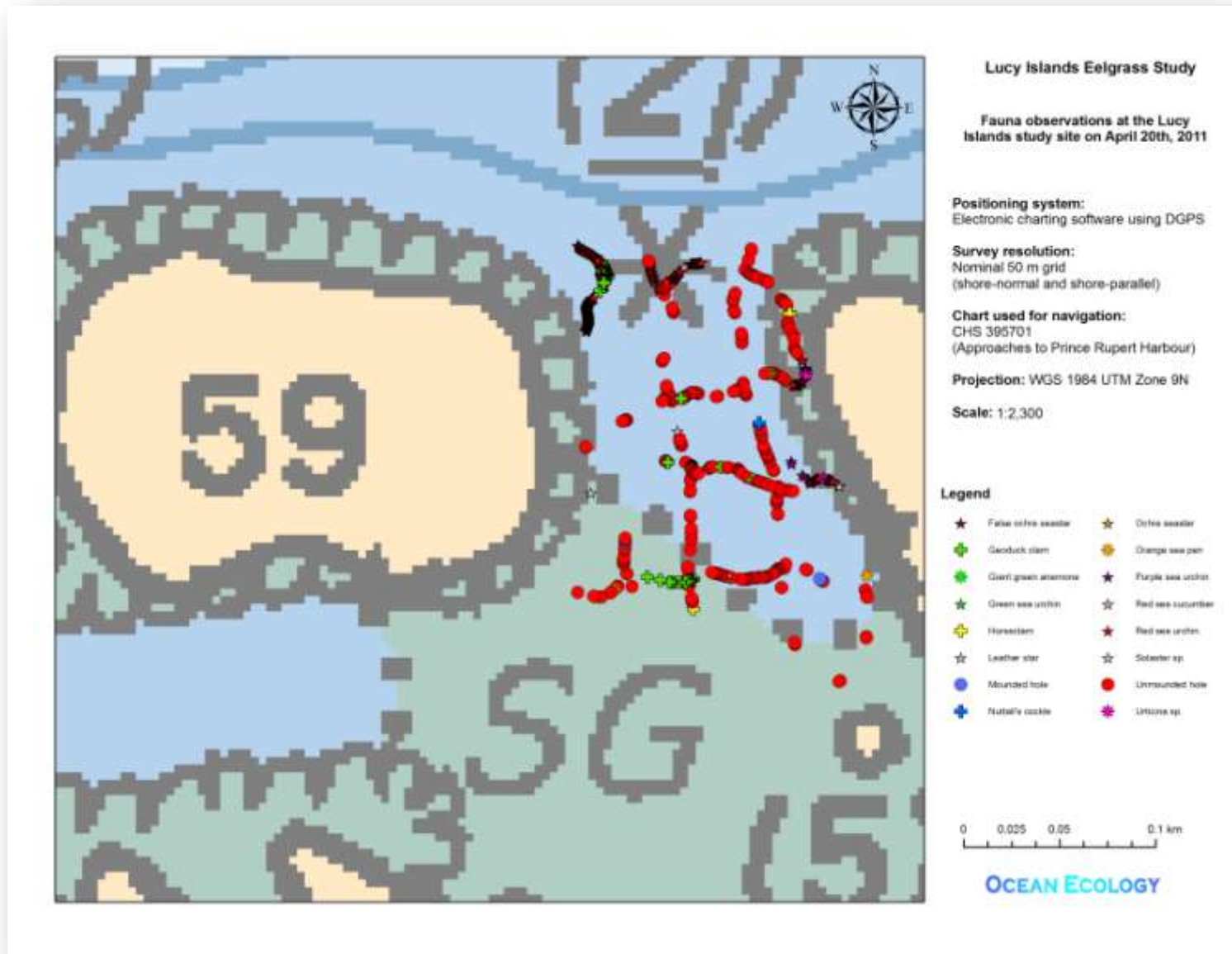

Figure 35. Fauna observations at the Lucy Islands study site on April 20<sup>th</sup>, 2011.

### 3.3.4 Diversity

The variation in species richness over the Lucy Islands study site is shown in Figure 36 (overview), Figure 37 (July), Figure 38 (October), and Figure 39 (April). In these maps, species richness is defined as the number of species observed in each hexagonal polygon (135 m<sup>2</sup>). Maximum species richness per polygon was 18 for the July survey, declined to 16 for the October survey, and then increased to 22 in April. High species richness correlates very well with high eelgrass density (see Figure 26, Figure 27, and Figure 28). The eelgrass is clearly providing suitable niches for a number of organisms. Eelgrass beds probably function to stabilize the mobile sand substrate, thus providing areas where other organisms can become anchored, such as algae and sessile fauna. Mobile fauna find food and refuges from predators in the eelgrass blades.

Total species richness for the north side of the Lucy Islands site is given in Table 4. Total species richness was 29 during the July survey, fell to 24 in October, and rose to 30 in April. Note that total species richness includes both flora and fauna species. During the April survey, the species richness of flora increased while the species richness of fauna decreased. However, the overall net result was an increase in total species richness.

Following the same trend as total species richness, the Shannon's diversity index (see Table 4) was also at a minimum in October and a maximum in April.

The Shannon's evenness value ranged from 0.898 in July to 0.941 in April (see Table 4). This indicates that the species are relatively evenly distributed throughout the site (a value of 1.0 would indicate a completely even distribution).

The Simpson's dominance index ranges from 0.343 in July to 0.200 in April. The Simpson's dominance index approaches 1.0 as one particular species dominates the site. A value of 0.200 to 0.343 suggests that there is only a small amount of dominance by organisms (particularly sea urchins) at the site, but no extreme dominance (e.g., there are relatively few locations at the site where only one species is found).

Table 4. Diversity indices for the north side of the Lucy Islands site

Diversity Index	July 2010 survey number of observations	October 2010 survey number of observations	April 2011 survey number of observations
Species richness	29	24	30
Shannon's diversity	3.025	2.888	3.201
Shannon's evenness	0.898	0.909	0.941
Simpson's dominance	0.343	0.290	0.200

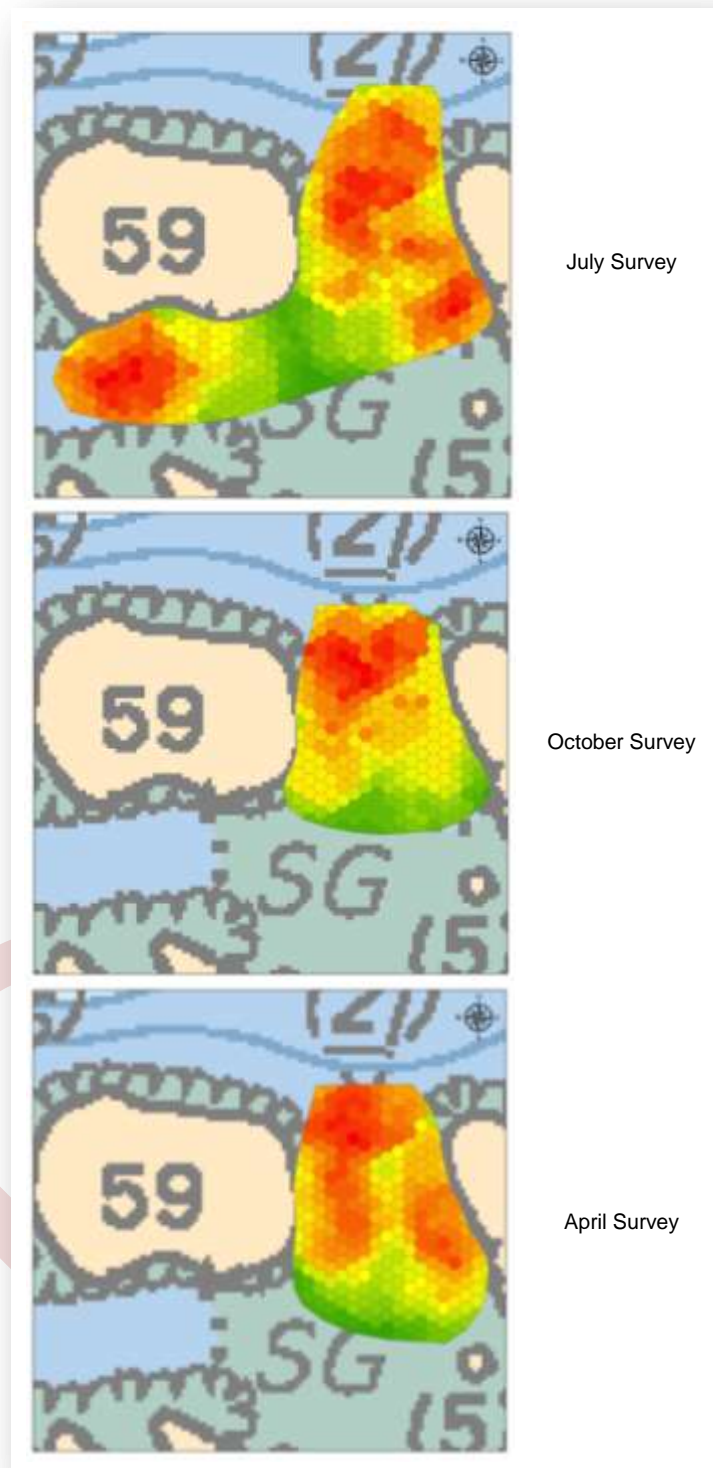

Figure 36. Overview of the temporal changes in species richness at the Lucy Islands study site.

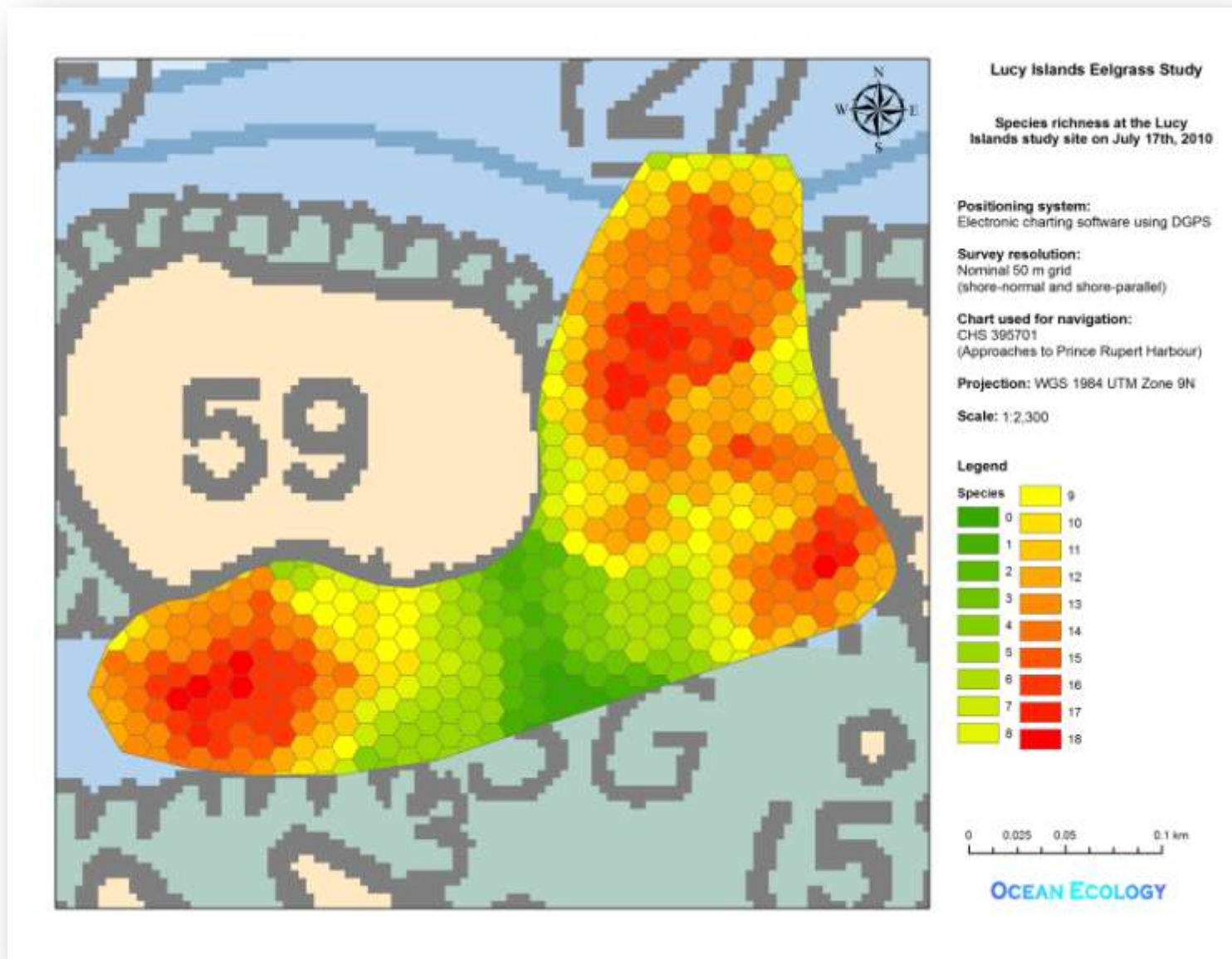

Figure 37. Species richness at the Lucy Islands study site on July 17<sup>th</sup>, 2010.



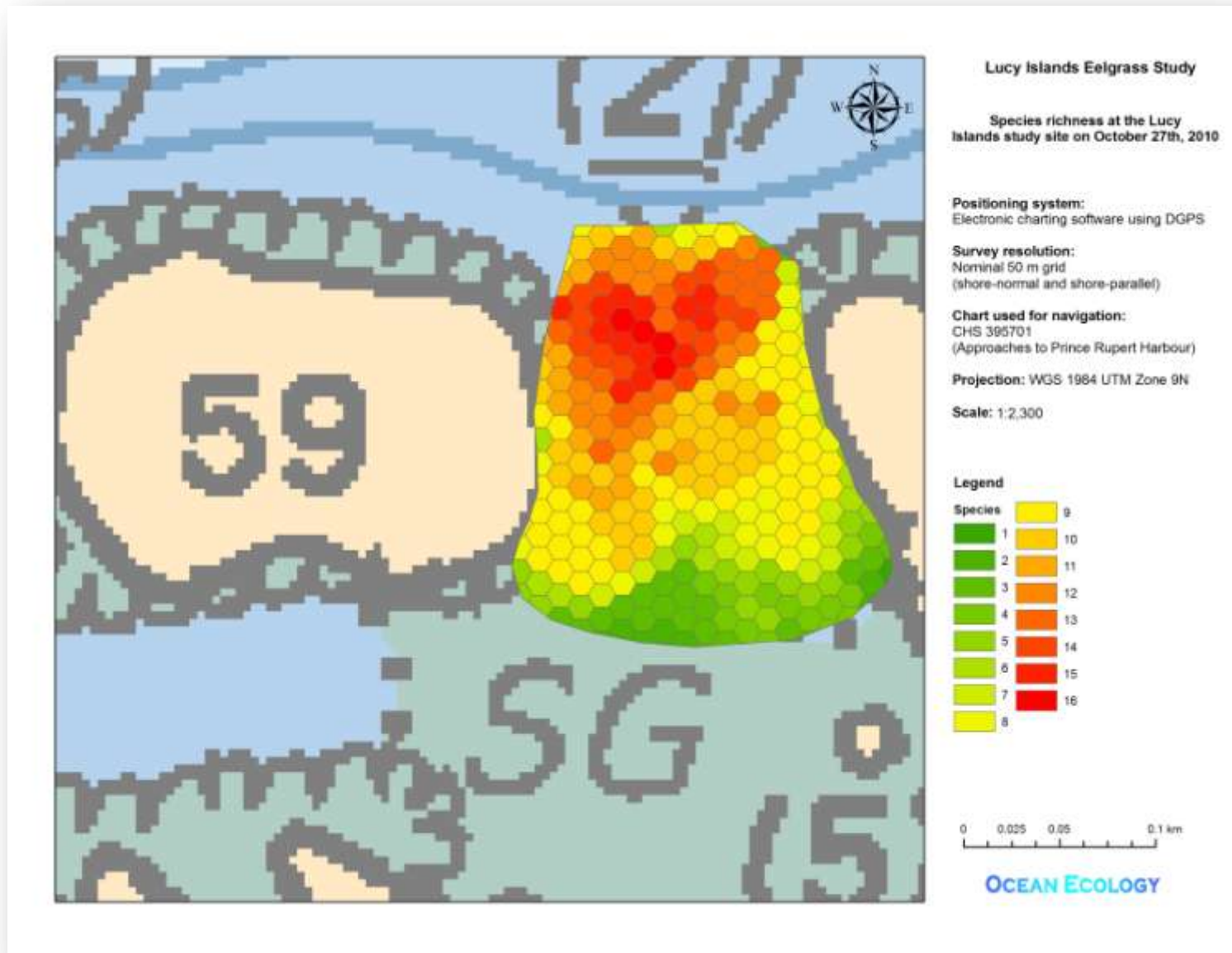

Figure 38. Species richness at the Lucy Islands study site on October 27<sup>th</sup>, 2010.

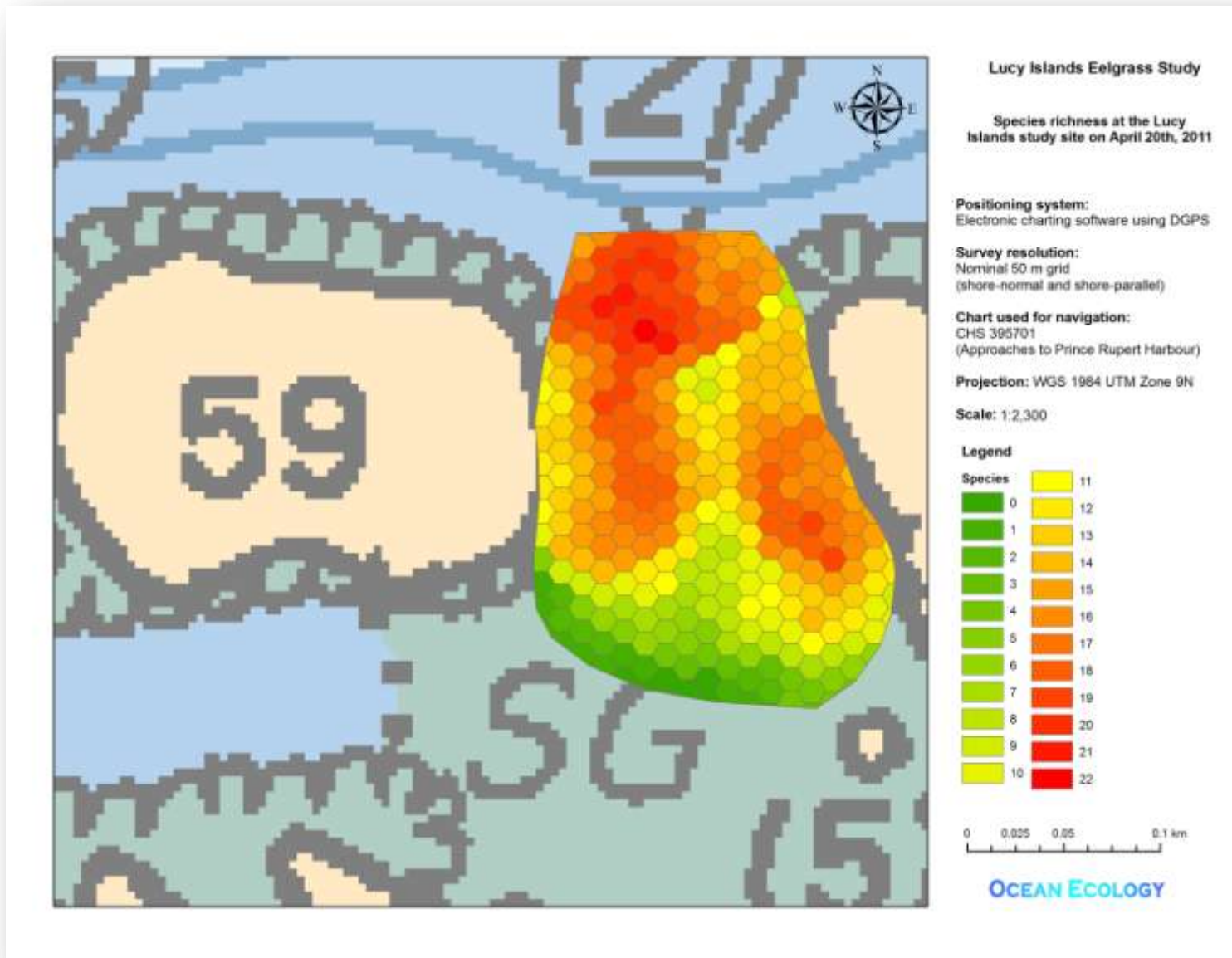

Figure 39. Species richness at the Lucy Islands study site on April 20<sup>th</sup>, 2011.

### 3.4 High Definition Drop Camera Survey

Shown below are two examples of images taken from the high definition drop camera survey at the Lucy Islands study site (see Figure 40 and Figure 41). These images demonstrate the level of resolution which can be achieved using this camera system.

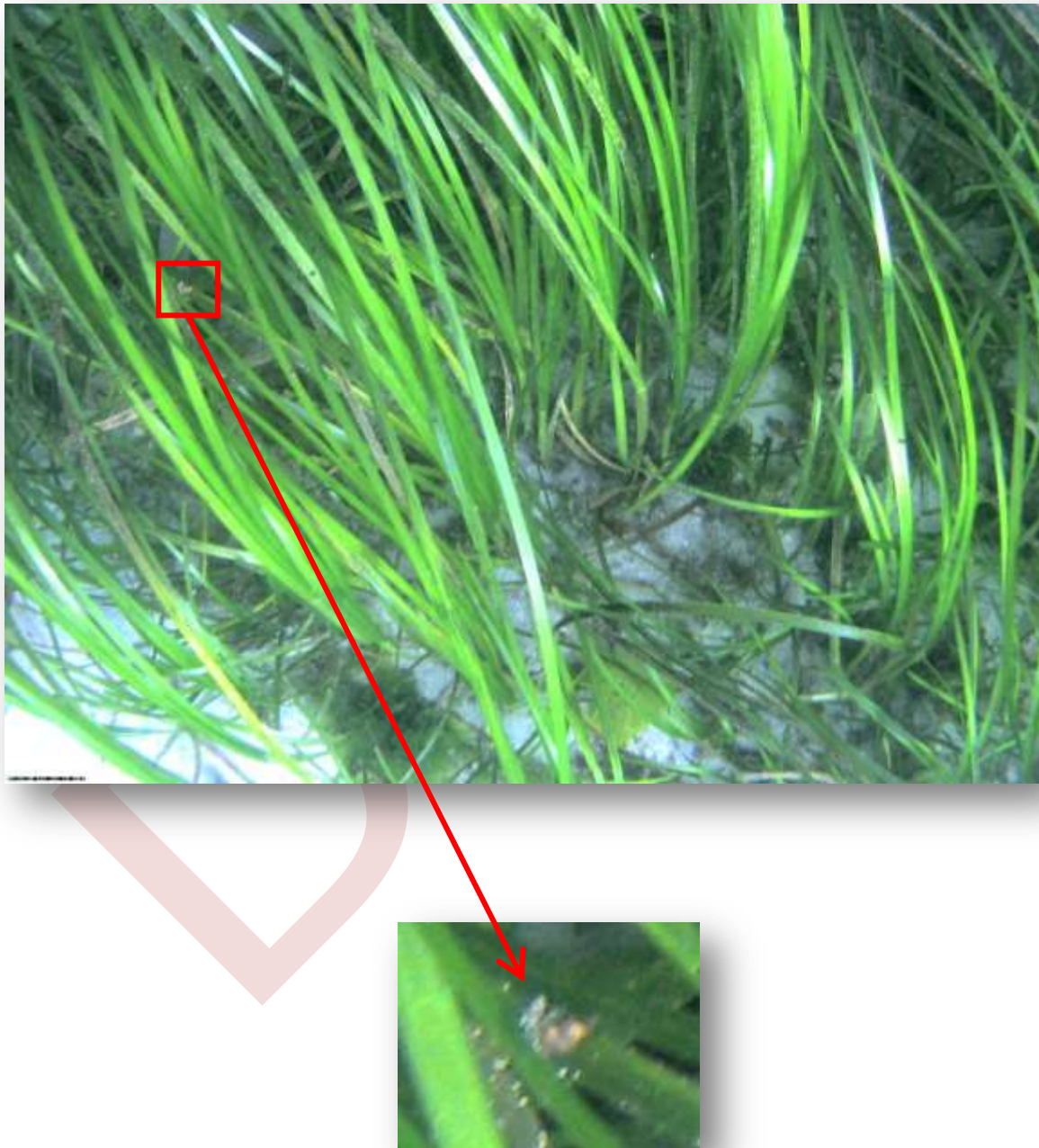

Figure 40. Image from the high definition drop camera showing a carinate dovesnail.

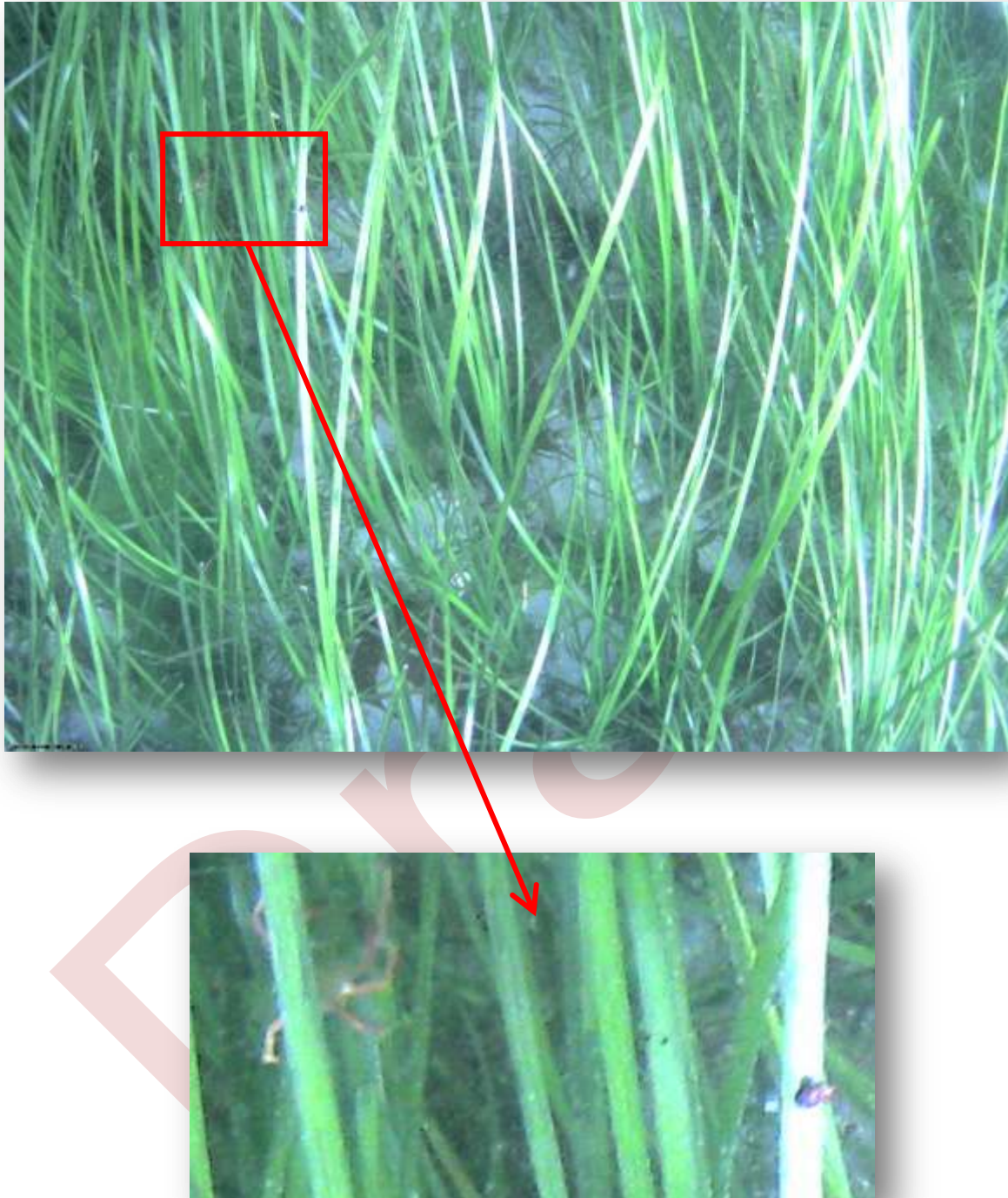

Figure 41. Image from the high definition drop camera showing a carinate dovesnail and a small kelp crab.

Using the photographs from the high definition drop camera survey, the eelgrass areal cover in each 0.25 m<sup>2</sup> quadrat could be accurately estimated (see Table 5). The locations of the camera drops and the estimated eelgrass cover are shown in Figure 42. Quadrats with the greatest eelgrass cover occurred on the west side of the study site. Quadrats with the lowest eelgrass cover were found largely in the central part of the site. These results correspond well with the data from the towed video survey (see Figure 30).

Eelgrass frequently co-occurred with algae (10 out of 15 quadrats had both algae and eelgrass). This appears to be fairly typical of eelgrass in northern British Columbia, where eelgrass is often found growing in mixed substrate. The presence of pebbles and cobbles in the mixed substrate provides good anchorage for algal holdfasts, thus allowing the algae to grow along with the eelgrass.

The leaf width of the eelgrass was measured on several quadrats, and ranged between 10 and 20 mm. This, along with the very long blade length, suggests that the eelgrass in the deeper waters of the Lucy Islands study site may be the *Zostera marina latifolia* ecotype (found between -0.5 and -10 m with strongest tolerance to current; has larger, wider blades; Precision Identification Biological Consultants, 2002).

Table 5. Analysis of high definition drop camera photographs.

Drop Number	Eelgrass areal cover (m <sup>2</sup> )	Algae species	Fauna species
1	0.03	Foliose greens; Foliose reds; Filamentous reds; Sugar wrack kelp	Eelgrass limpet; Carinate dovesnail; Threaded bittium
2	0.01	--	Unmounded hole
3	0.001	Coralline reds; Foliose reds; Filamentous reds; Sugar wrack kelp	--
4	0.14	Foliose reds; Foliose greens	--
5	0.13	Foliose greens	Eelgrass limpet; Unmounded hole
6	0.15	Foliose reds; Foliose greens	Carinate dovesnail
7	0.09	Foliose reds; Foliose greens	Eelgrass limpet; Carinate dovesnail
8	0.06	Foliose greens; Suction-cup kelp	Carinate dovesnail
9	0.22	--	Eelgrass limpet
10	0.19	Foliose reds; Foliose greens	Eelgrass limpet
11	0.13	Foliose reds; Foliose greens; Suction-cup kelp; Sugar wrack kelp	Carinate dovesnail
12	0.23	--	Carinate dovesnail
13	0.23	--	Eelgrass limpet
14	0.17	Foliose greens	Carinate dovesnail
15	0.24	--	Eelgrass limpet; Carinate dovesnail

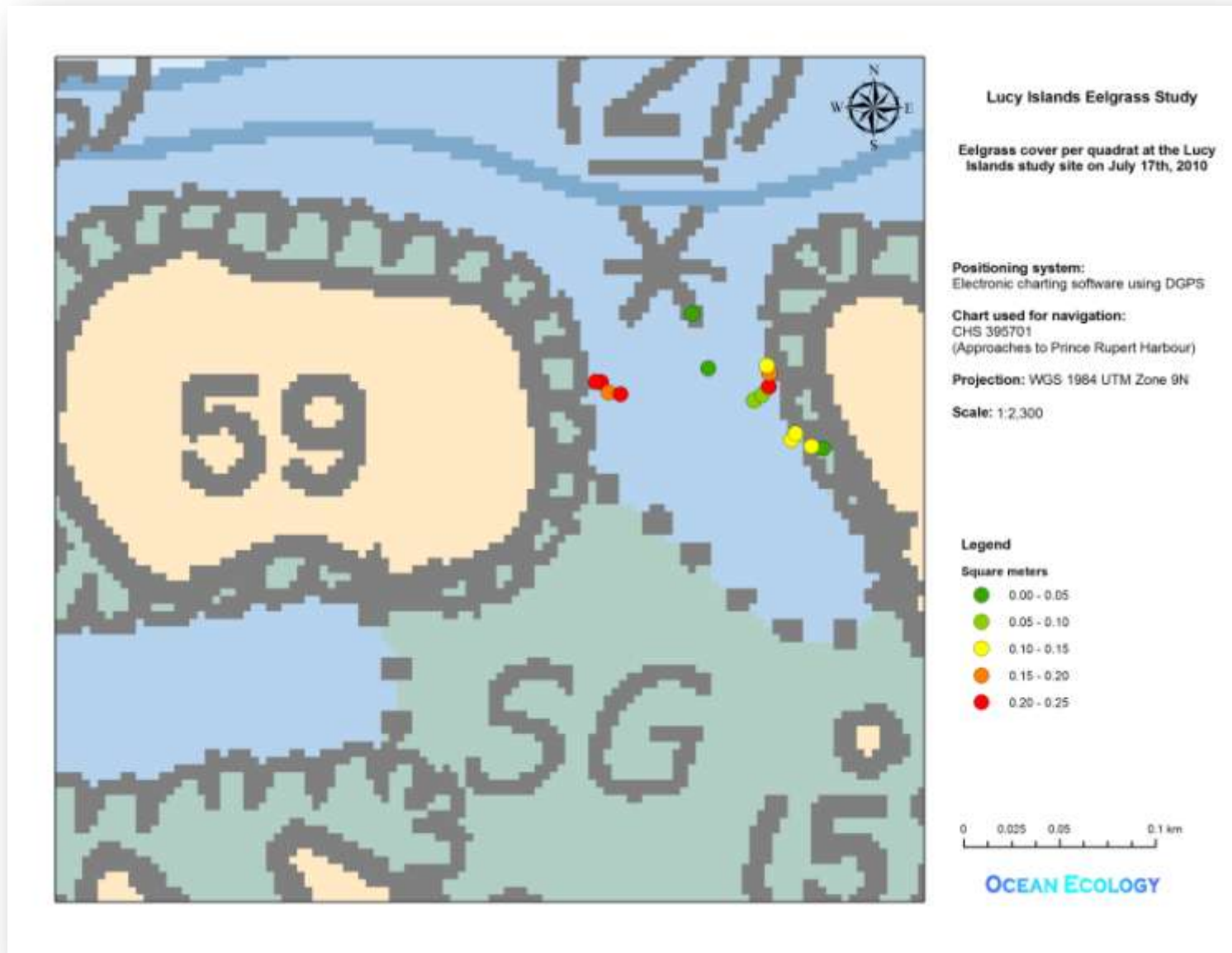

Figure 42. Eelgrass cover per quadrat at the Lucy Islands study site on July 17<sup>th</sup>, 2010.

### **3.5 Side Scan Sonar Survey**

#### *3.5.1 Raw Side Scan Sonar Data*

Figure 43 shows an example of the raw side scan sonar data taken from the Lucy Islands study site as viewed by the HumViewer software. This image shows a side scan pass over the eelgrass bed. The four panels on the image give the following information:

- Top left - 455 kHz down image. The eelgrass is visible as rounded clumps on the seafloor.
- Top right - 455 kHz side scan image. The eelgrass is visible as rounded contours on both sides of the side scan.
- Bottom left - 200 kHz downward-looking sonar. The eelgrass is visible as standing clumps above the seafloor. The higher frequency sonar provides a bit more internal detail of the eelgrass bed structure.
- Bottom right - 83 kHz downward-looking sonar. The eelgrass is visible as standing clumps above the seafloor. The lower frequency sonar has greater penetration of the seafloor and dense patches of eelgrass.

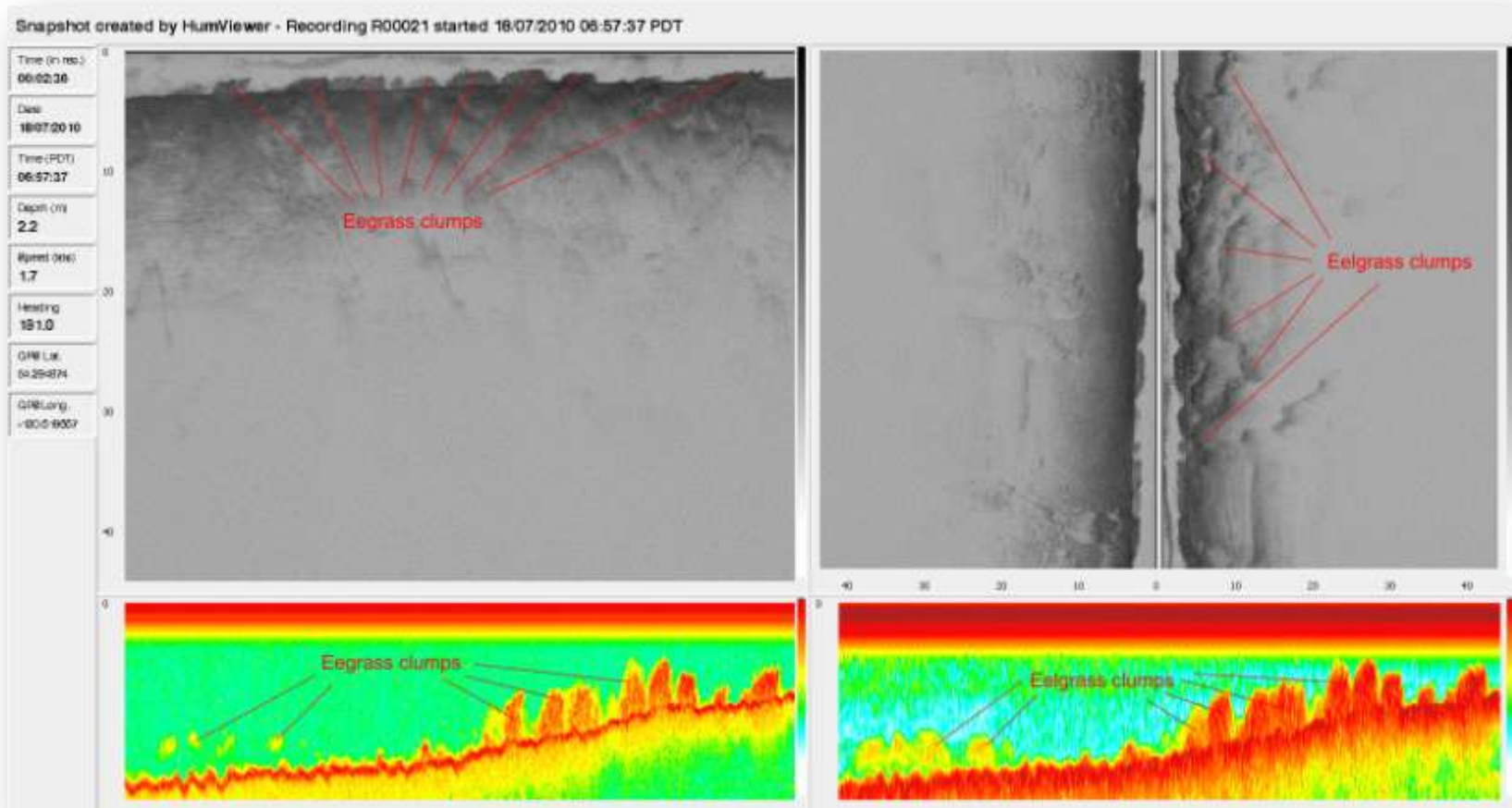

Figure 43. An example of raw side scan sonar data as viewed by the HumViewer software.



### *3.5.2 Simple Georeferencing and Mosaicing of the Side Scan Sonar Data*

Figure 44 shows an example of a single raw side scan sonar image which has been georeferenced. This image is a good illustration of the pattern of distribution of eelgrass at the study site. Note that the eelgrass is visible as small clumps and strips, and that the distribution is discontinuous. The side scan sonar image gives a much better picture of the overall eelgrass pattern than the towed video camera, which has a field of view of approximately 0.5 m to 1.0 m on the downward-looking camera. This narrow field of view means that the towed video camera will miss many of the small patches of eelgrass, and can only provide information on patch frequency along the towed transect line. Essentially, the towed video camera survey is a one-dimensional (e.g., transect) survey whereas the side scan sonar survey is a two-dimensional survey.

Simple mosaics of the side scan images for each survey are shown in Figure 46 (July), Figure 47 (October), and Figure 48 (April). These mosaics show the extent of the side scan coverage at the site during each survey. They also provide an initial impression of the amount of eelgrass present at the site. Most of the region surveyed using the side scan sonar had some amount of eelgrass present, if only in small patches. This is in agreement with the video survey, which also showed that eelgrass was present throughout the site. The side scan sonar mosaics also showed that the eelgrass clumps tended to be larger and more well-defined along the east and west sides of the channel, and smaller and patchier towards the center of the channel, and at the north and south boundaries of the site. Again, this agreed well with the video observations (see section 3.3.2.2). Finally, the eelgrass clumps in the July survey appeared larger and more sharply defined than the eelgrass clumps during the October and April surveys (see Figure 45). This suggests that the eelgrass in July was more abundant, and possibly that the clumps were taller (e.g., produced sharper “shadows” in the side scan images).

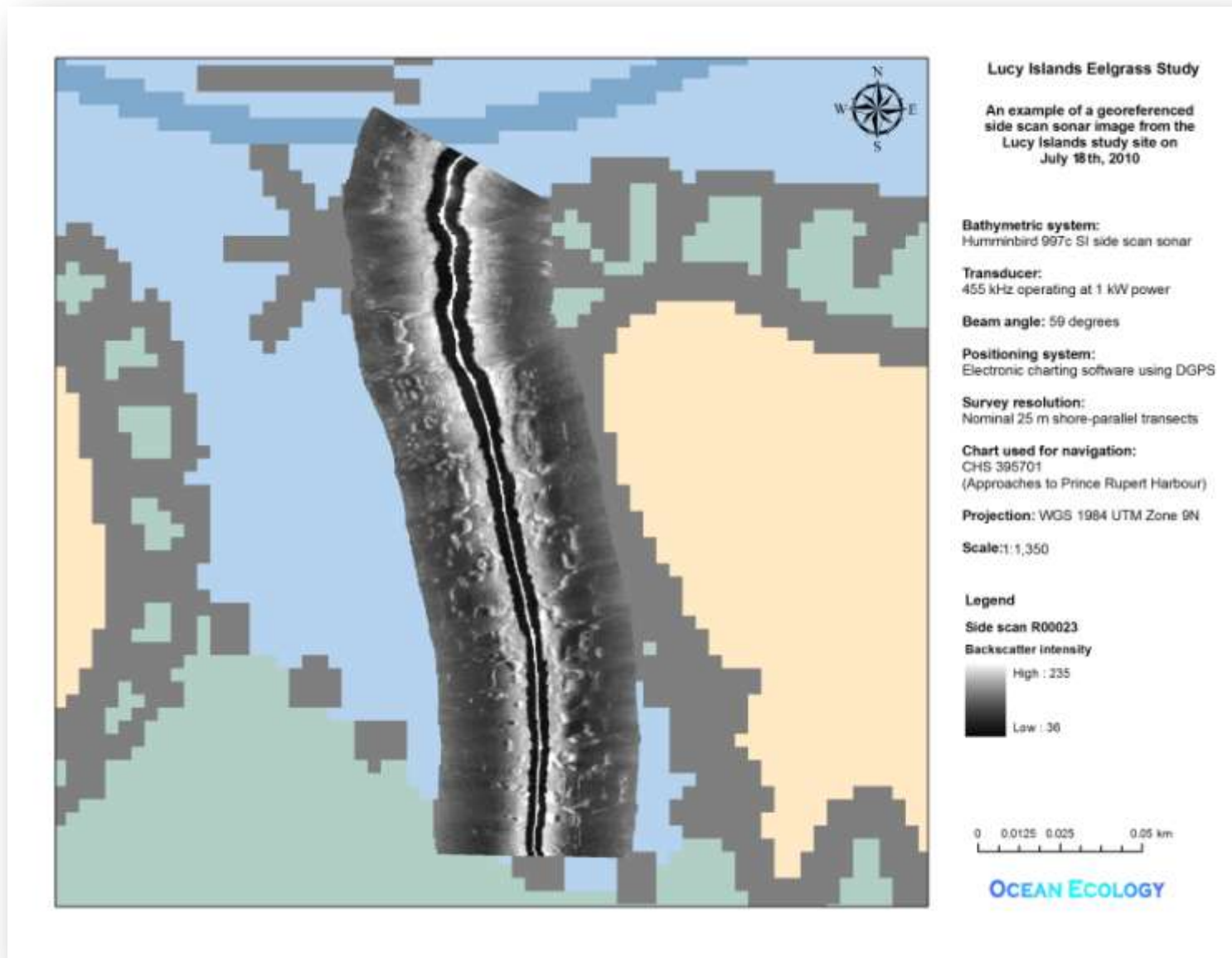

Figure 44. An example of a georeferenced side scan sonar image from the Lucy Islands study site on July 18<sup>th</sup>, 2010.

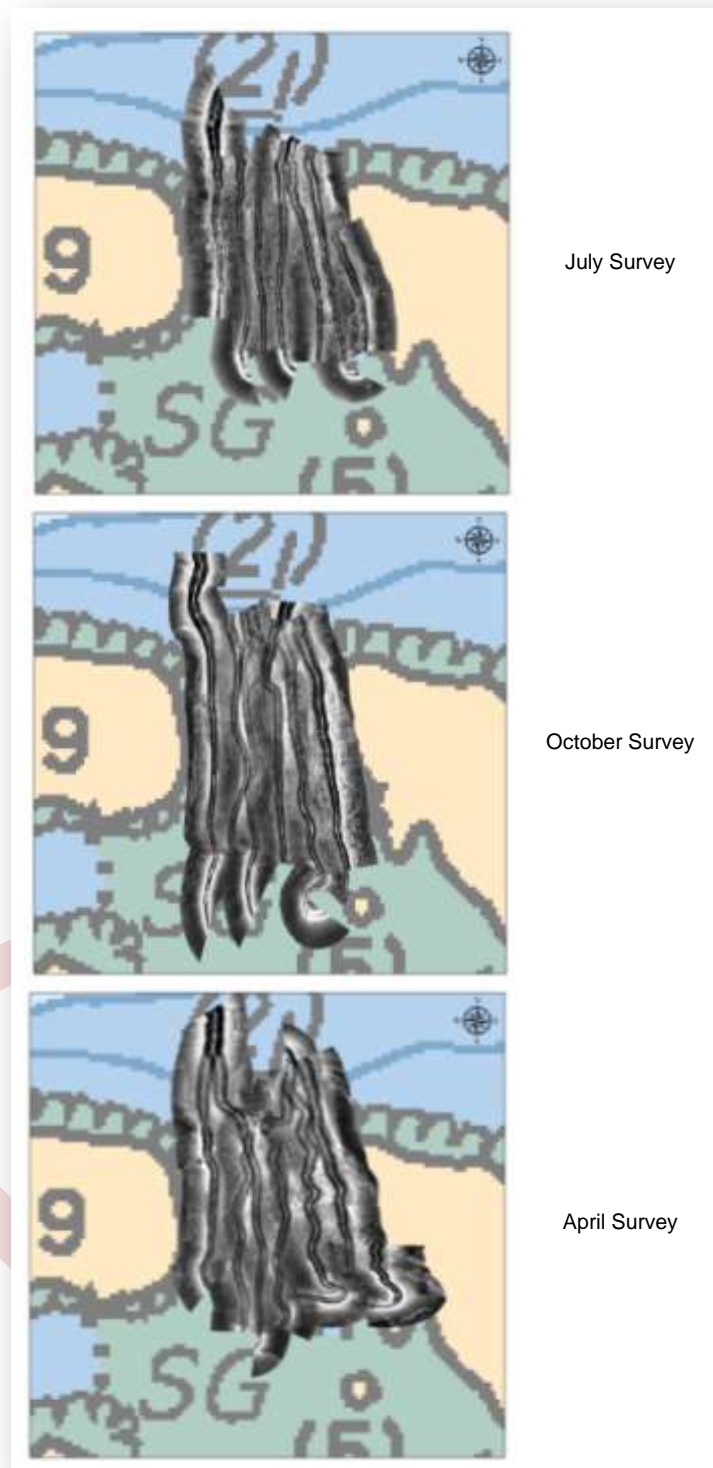

Figure 45. Overview of the temporal changes in eelgrass at the Lucy Islands study site as seen by the simple side scan sonar mosaics.

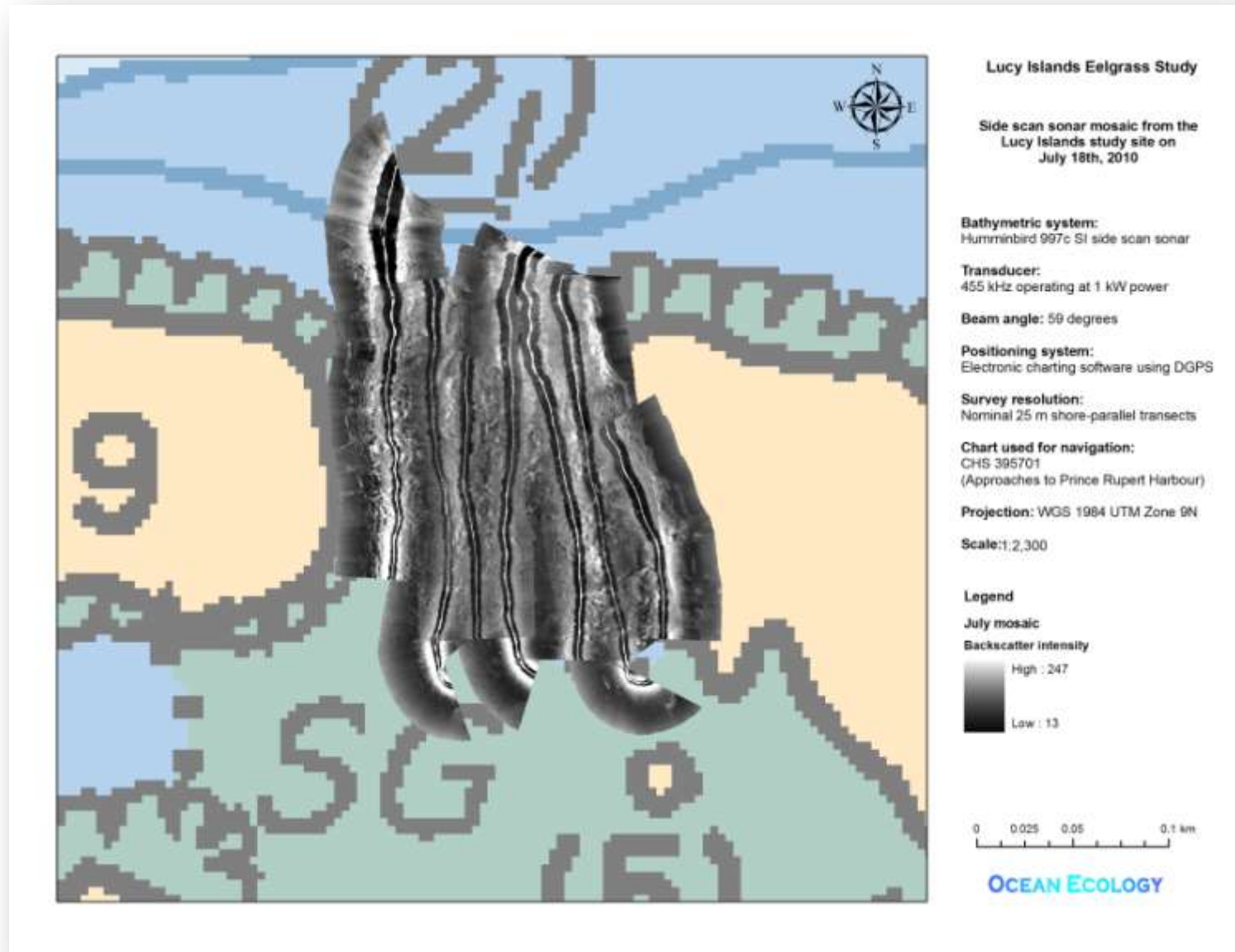

Figure 46. Side scan mosaic from the Lucy Islands study site on July 18<sup>th</sup>, 2010.

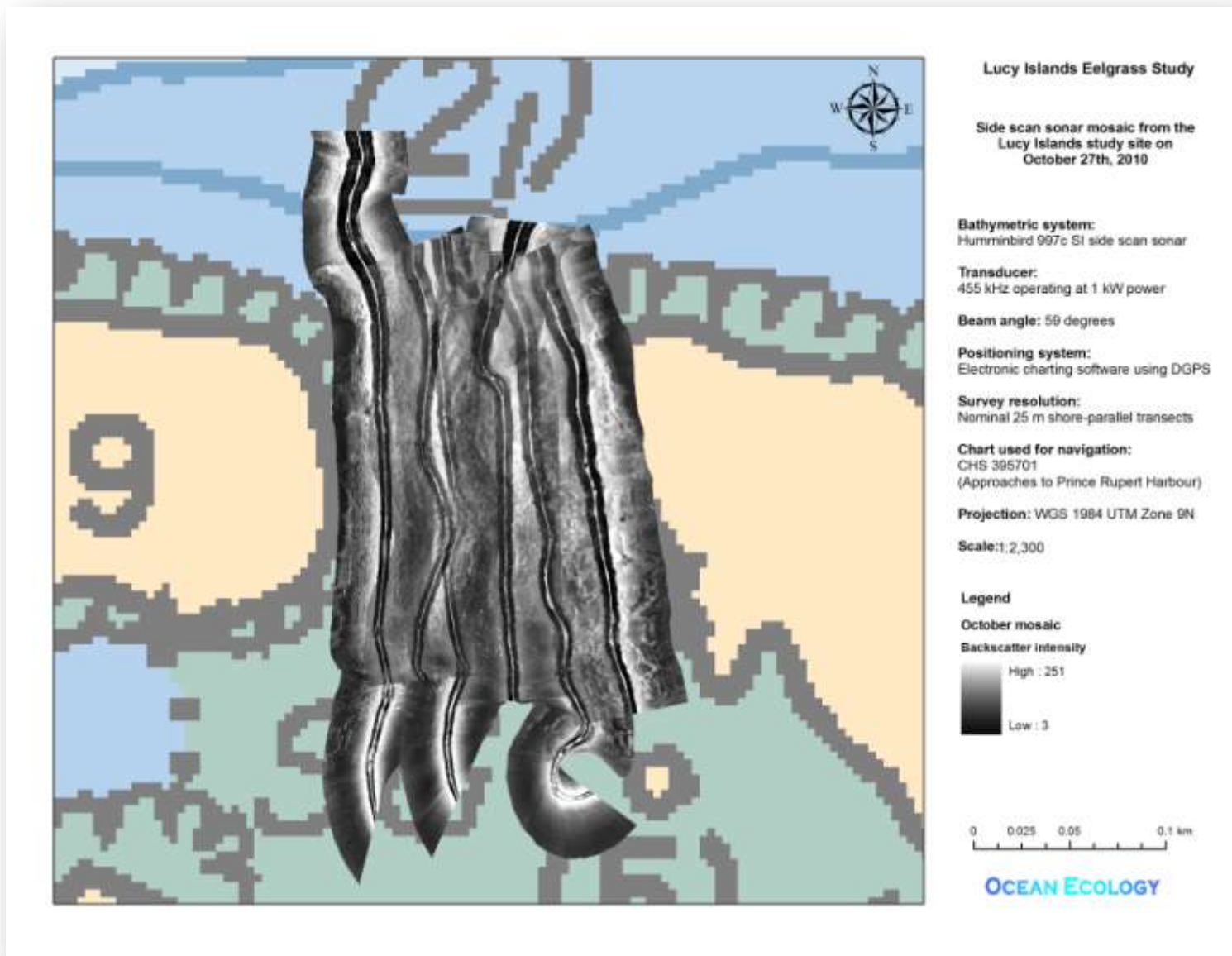

Figure 47. Side scan mosaic from the Lucy Islands study site on October 27<sup>th</sup>, 2010.

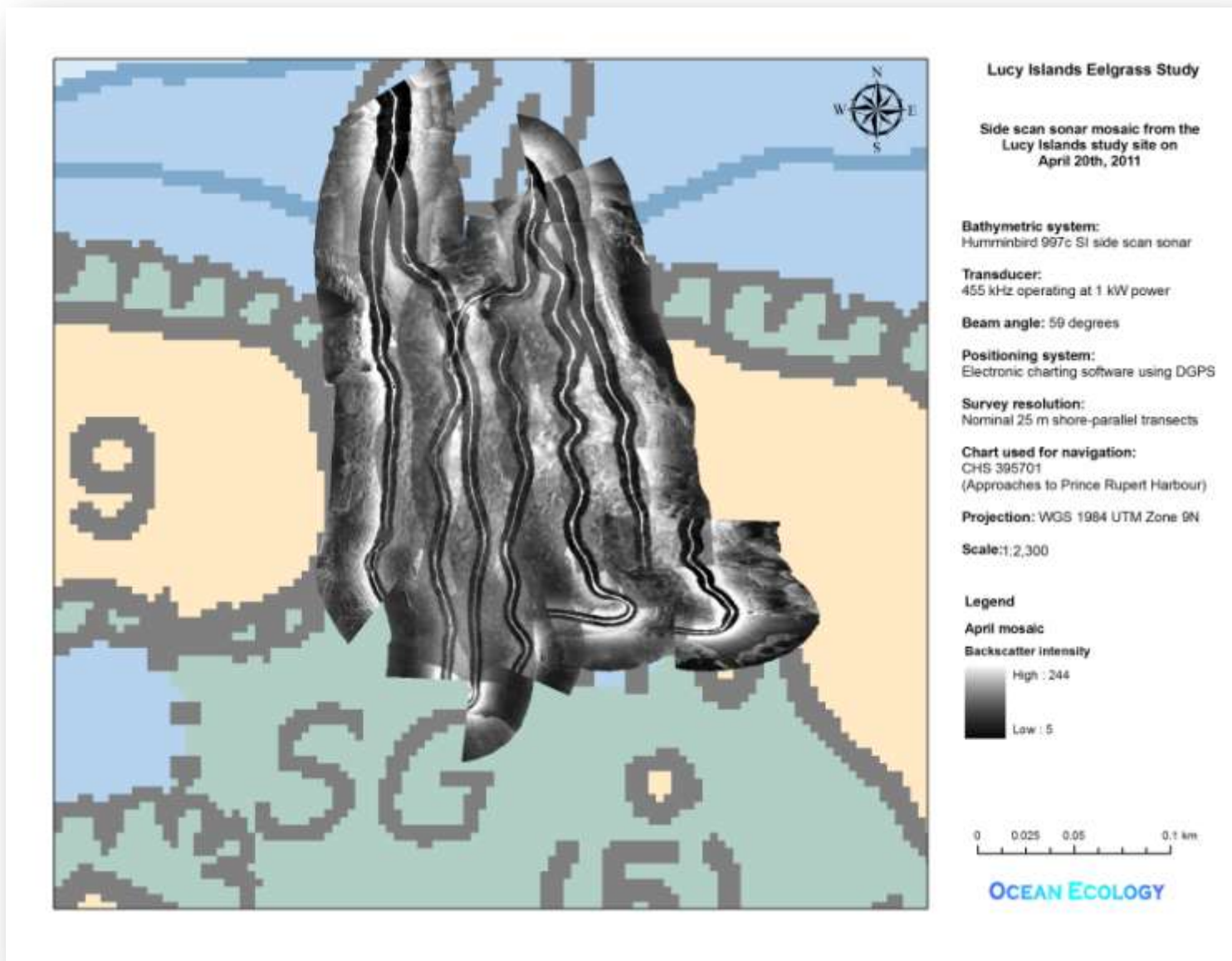

Figure 48. Side scan mosaic from the Lucy Islands study site on April 20<sup>th</sup>, 2011.

3.5.3 Calculation of Eelgrass Cover Using Grey Level Co-occurrence Matrices (GLCM)

The eelgrass cover at the Lucy Islands study site, as calculated using grey level co-occurrence matrices, is shown in Figure 50 (July), Figure 51 (October), and Figure 52 (April). Also shown in these figures is the 50% expected population contour as determined by the video analysis (see section 3.3.2.2). Blue and green pixels have a high likelihood of being eelgrass, whereas yellow and red pixels have a much lower likelihood of being eelgrass. Pixels with zero probability of being eelgrass have been removed from the figure.

In the July survey, the pixels with a high probability of being eelgrass fell mostly within the 50% expected population contour, indicating good correlation between the video and side scan sonar data. However, the correlation between video and side scan sonar data is much poorer for the October and April surveys. The lower level of correlation during the winter and spring surveys can be explained as follows. The expected population contours derived from the video analysis are based on observations of both spatial cover and density. However, the GLCM analysis of the side scan sonar data is based on spatial cover alone, and does not take density into account. During the July survey, the eelgrass was both denser and had greater spatial coverage in the region delimited by the 50% expected population contour, thus there was good correlation between the video and side scan analysis. In the October and April surveys, erosion of the eelgrass blades had reduced its spatial cover, but its stem count (e.g., density) remained higher in some areas than others. Thus, the GLCM analysis of the side scan data indicated small clumps of eelgrass distributed more or less throughout the entire site, while the video analysis showed that density (e.g., stem counts) was higher along the sides of the channel.

Temporal changes in the eelgrass cover as calculated by GLCM analysis are not initially easy to discern (see Figure 49). This is due in part to the relatively homogenous spatial distribution of eelgrass throughout the site. However, it is possible to calculate a rough measure of eelgrass “abundance” for comparative purposes using the following equation:

$$\text{Measure of eelgrass abundance} = \sum_{i=1}^n (P_i \times N_i)$$

where  $P_i$  is the probability that pixels in class  $i$  are eelgrass and  $N_i$  is the number of pixels in class  $i$ . The results of this calculation are given in Table 6. “Abundance” was highest in July, dropped significantly in October, and then increased a bit in April. This agrees well with the pattern shown in the temporal variations in eelgrass density seen by examining the area of the region encompassed by the 50% expected population contour (see section 3.3.2.2).

Table 6. Comparison of eelgrass abundance between surveys.

Parameter	July 2010 survey	October 2010 survey	April 2011 survey
Measure of eelgrass abundance	3,389,855	1,259,069	2,011,585

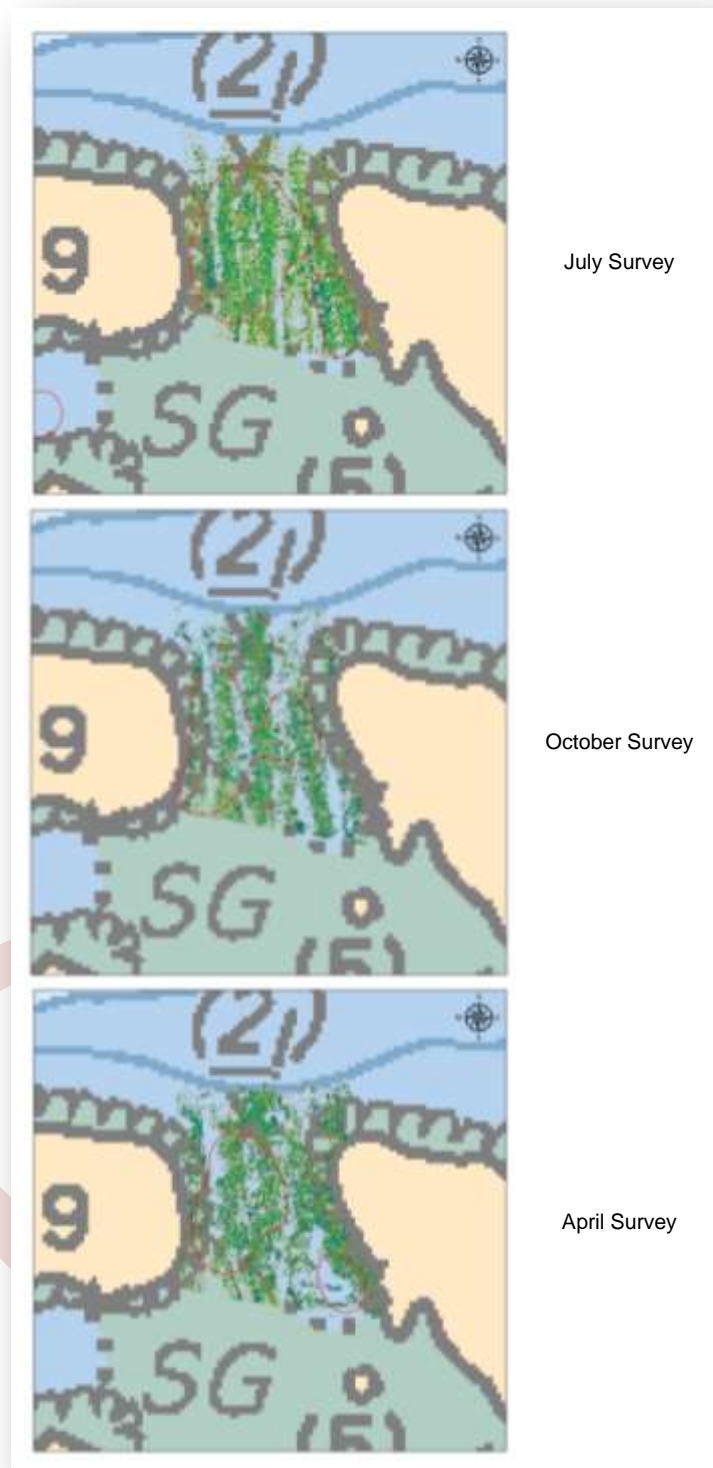

Figure 49. Overview of the temporal changes in eelgrass cover at the Lucy Islands study site as calculated using GLCM analysis.



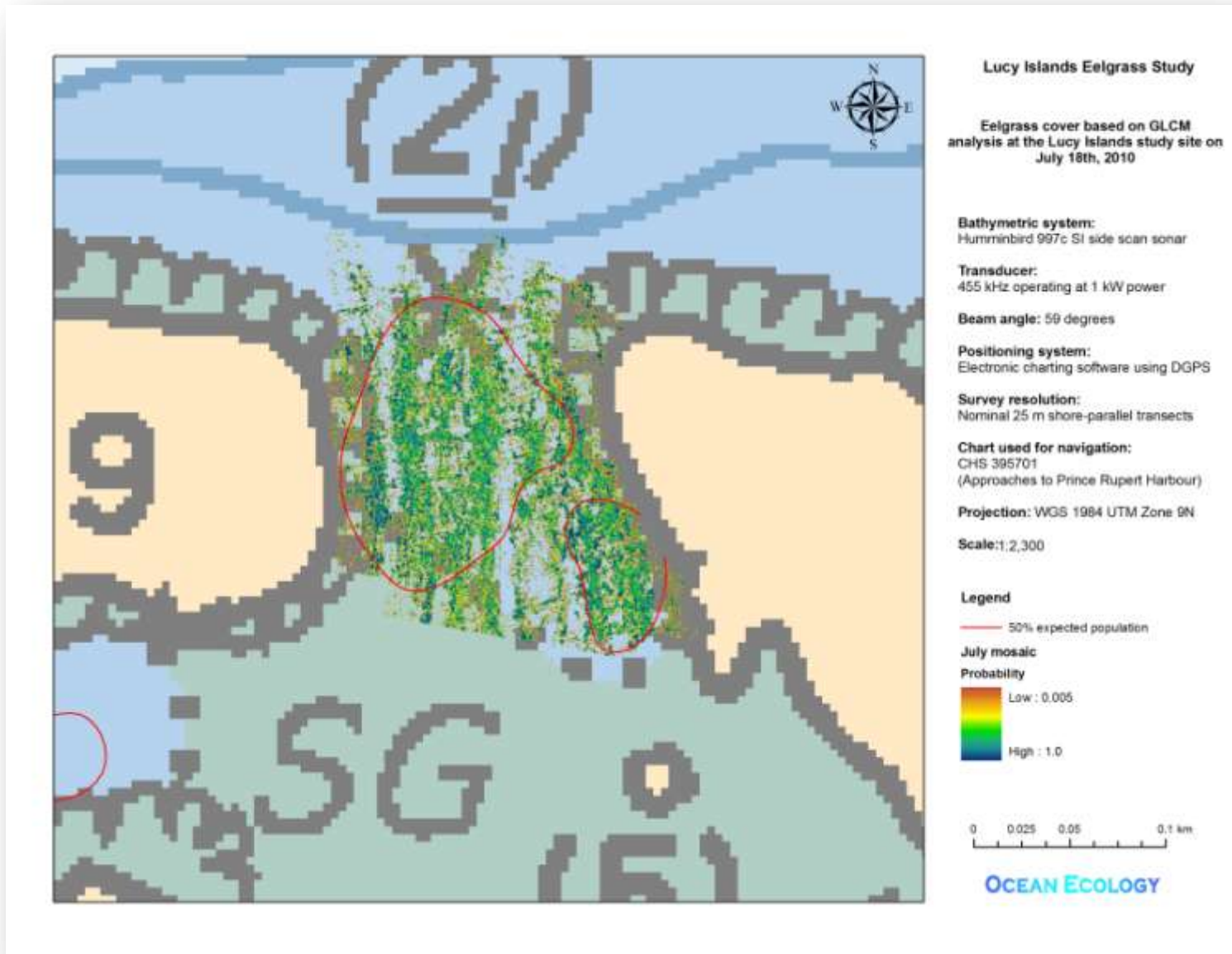

Figure 50. Eelgrass cover based on GLCM analysis at the Lucy Islands study site on July 18<sup>th</sup>, 2010.

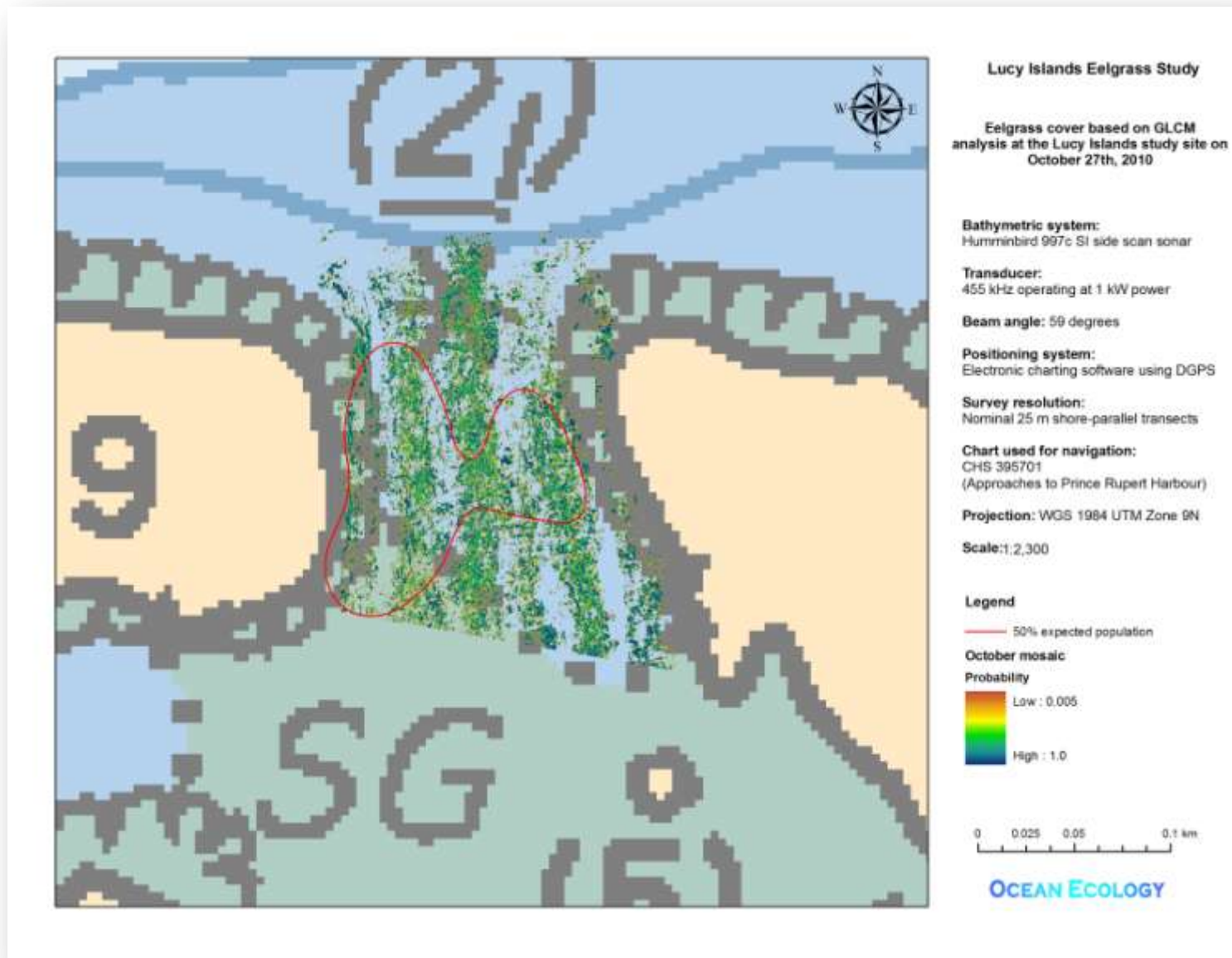

Figure 51. Eelgrass cover based on GLCM analysis at the Lucy Islands study site on October 27<sup>th</sup>, 2010.

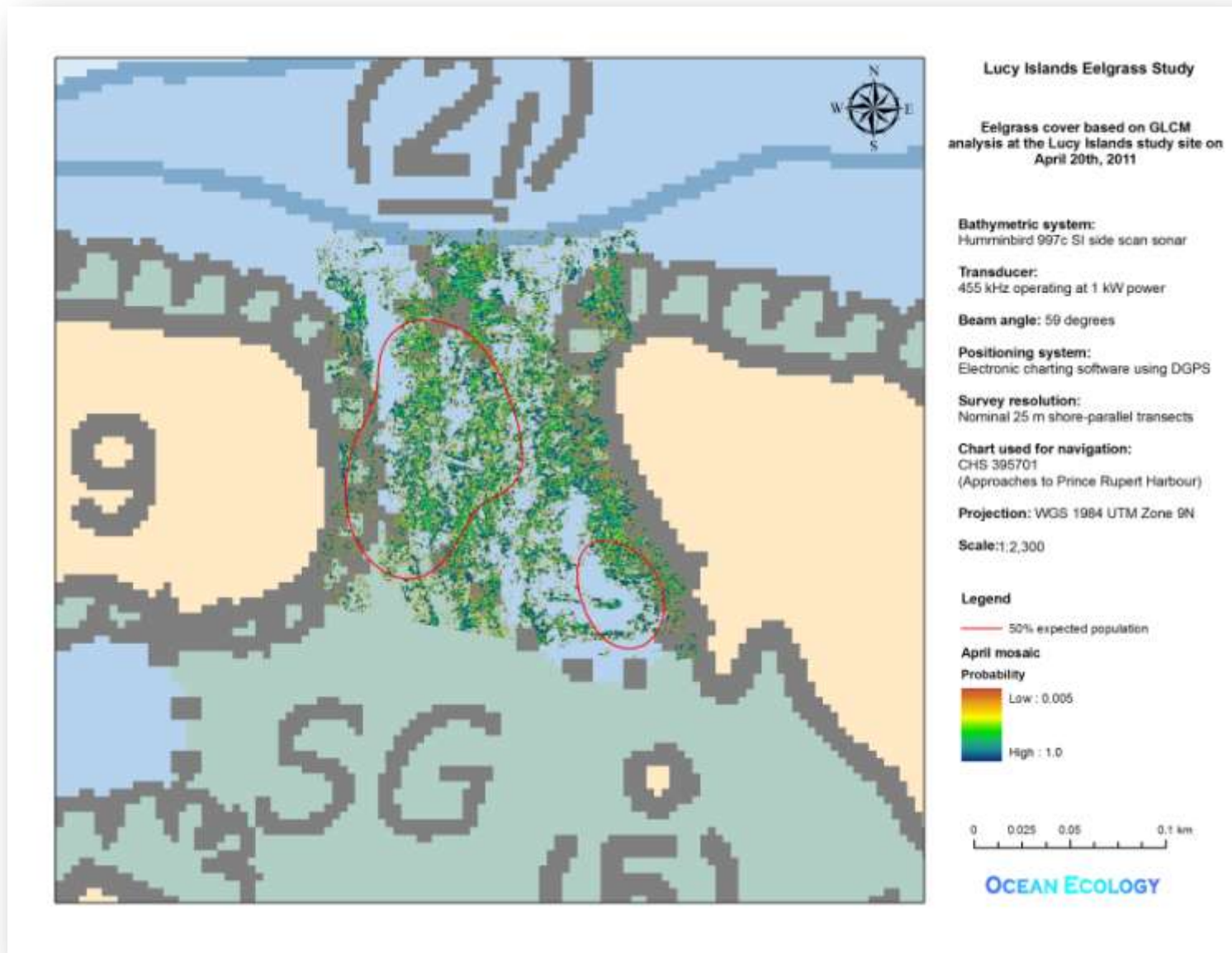

Figure 52. Eelgrass cover based on GLCM analysis at the Lucy Islands study site on April 20<sup>th</sup>, 2011.

#### 3.5.4 Processing of Side Scan Sonar Data

Processing of side scan sonar data using software such as MIPS or MB-System provides the following enhancements:

- corrections for changes in shading as a result of changes in horizontal beam angle
- noise removal
- better georeferencing resulting from corrections for slant range geometry problems
- removal of horizontal striping in the image
- removal of some or all of the artifacts created in the central or nadir region of the side scan image
- corrections for variations in ship speed and spatial resolution differences in the along-track versus across-track directions

Mosaics created by the MIPS software are shown in Figure 53 (overview), Figure 54 (July), Figure 55 (October), and Figure 56 (April). As before, the eelgrass is visible as discontinuous clumps in all three figures. However, unlike the simple mosaics created using Deep View Publisher, the nadir artifacts have been almost completely removed. The georeferencing of the images is also much better. This is particularly noticeable if you compare the MIPS mosaic for April (Figure 56) with the simple mosaic created using Deep View Publisher (Figure 48) for the same data set. In the MIPS mosaic, the georeferencing for the side scan data on the southeast corner is much less skewed, and positioning relative to the shore is better.

A comparison between the MIPS software and the MB-System software was made using side scan data from the July survey. The MIPS mosaic of this data is shown in Figure 54 and the MB-System mosaic of the same data is shown in Figure 57. The georeferencing on both images is almost the same. However, the eelgrass is much less well defined on the MB-System mosaic (has much softer, reduced shadows), and the nadir artifacts are still quite evident at some locations. As a result, MIPS was used for all further side scan mosaics in this study.

False-coloring and use of the “hill-shade effect” (a method of representing relief on a map by depicting the shadows that would be cast by high ground if light were shining from a certain direction) can further assist in visualizing the location of the eelgrass in the side scan mosaics. Figure 58 (overview), Figure 59 (July), Figure 60 (October), and Figure 61 (April) demonstrate false-coloring of MIPS mosaics. The green color represents areas of high back scatter intensity. Where the seafloor was relatively flat, clumps of eelgrass had higher back scatter intensity than the surrounding sand, and thus are given a green color. Note, however, that there are some back scatter artifacts at the south end of the site where the ship entered very shallow water and had to turn sharply to avoid the beach. In this region, the highest back scatter intensity was from the sloping beach face.

In order to compare the false-colored mosaics with the video data, the 50% and 90% expected population contours as determined from the video data are shown in Figure 59, Figure 60, and Figure 61. In general, there is fairly good correlation between the two data sets, with the regions of highest backscatter intensity falling mostly within the 50% expected population contour, and the remainder falling with the 90% expected population contour. Some of the high back scatter intensity very close to the sides of channel may be due to boulders, making the eelgrass differentiation difficult in these areas.

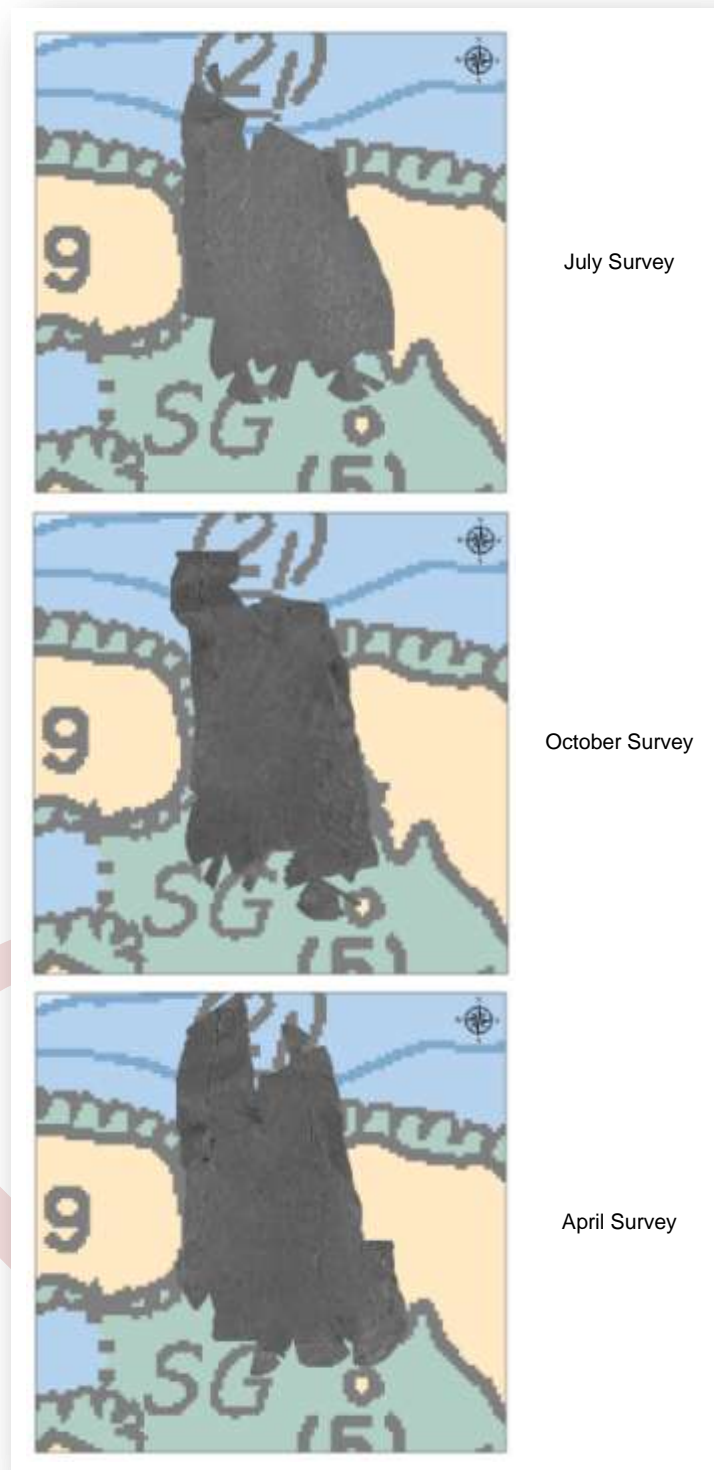

Figure 53. Overview of the temporal changes in eelgrass at the Lucy Islands study site as seen by the MIPS processed side scan sonar.

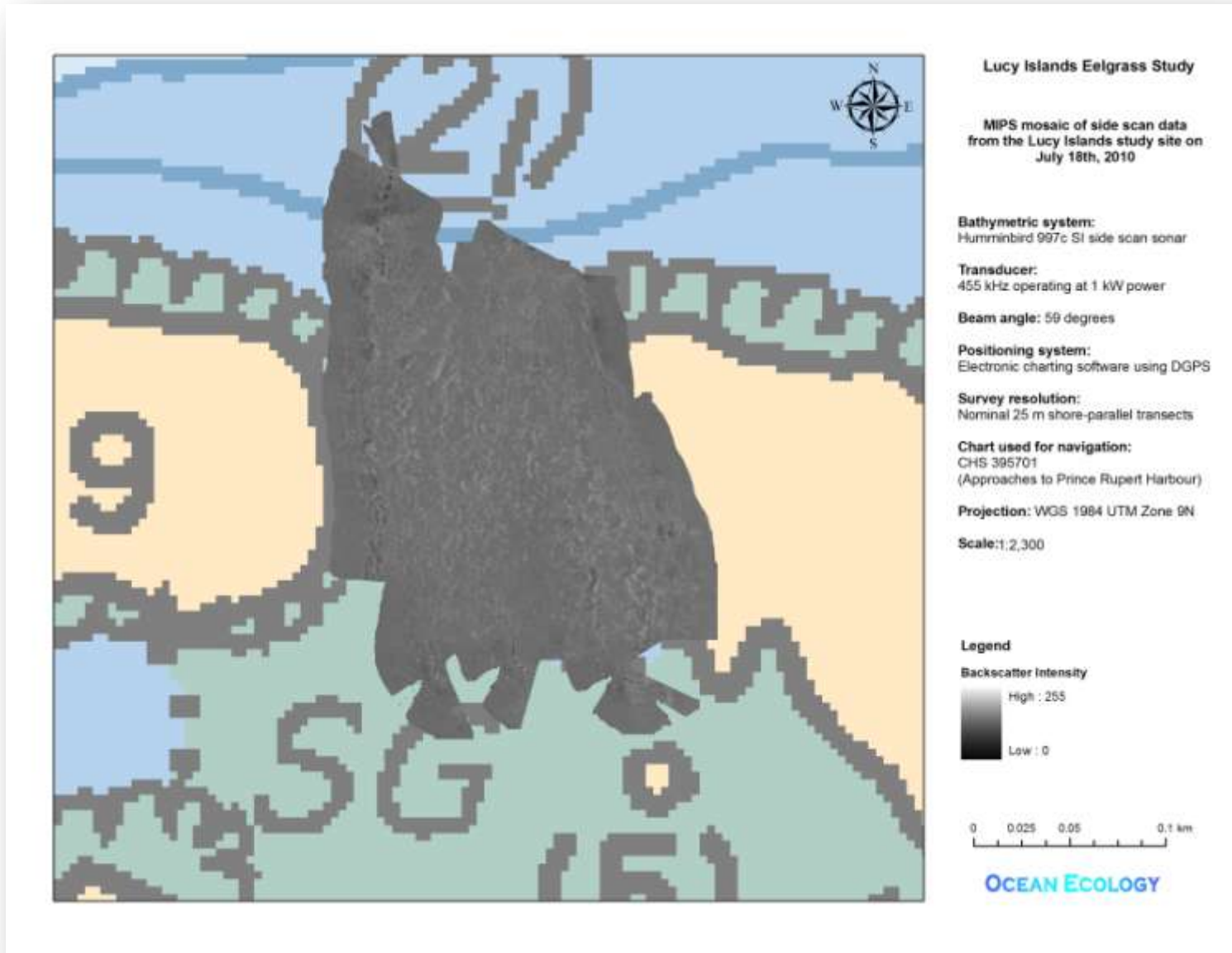

Figure 54. MIPS mosaic of side scan data from the Lucy Islands study site on July 18<sup>th</sup>, 2010.

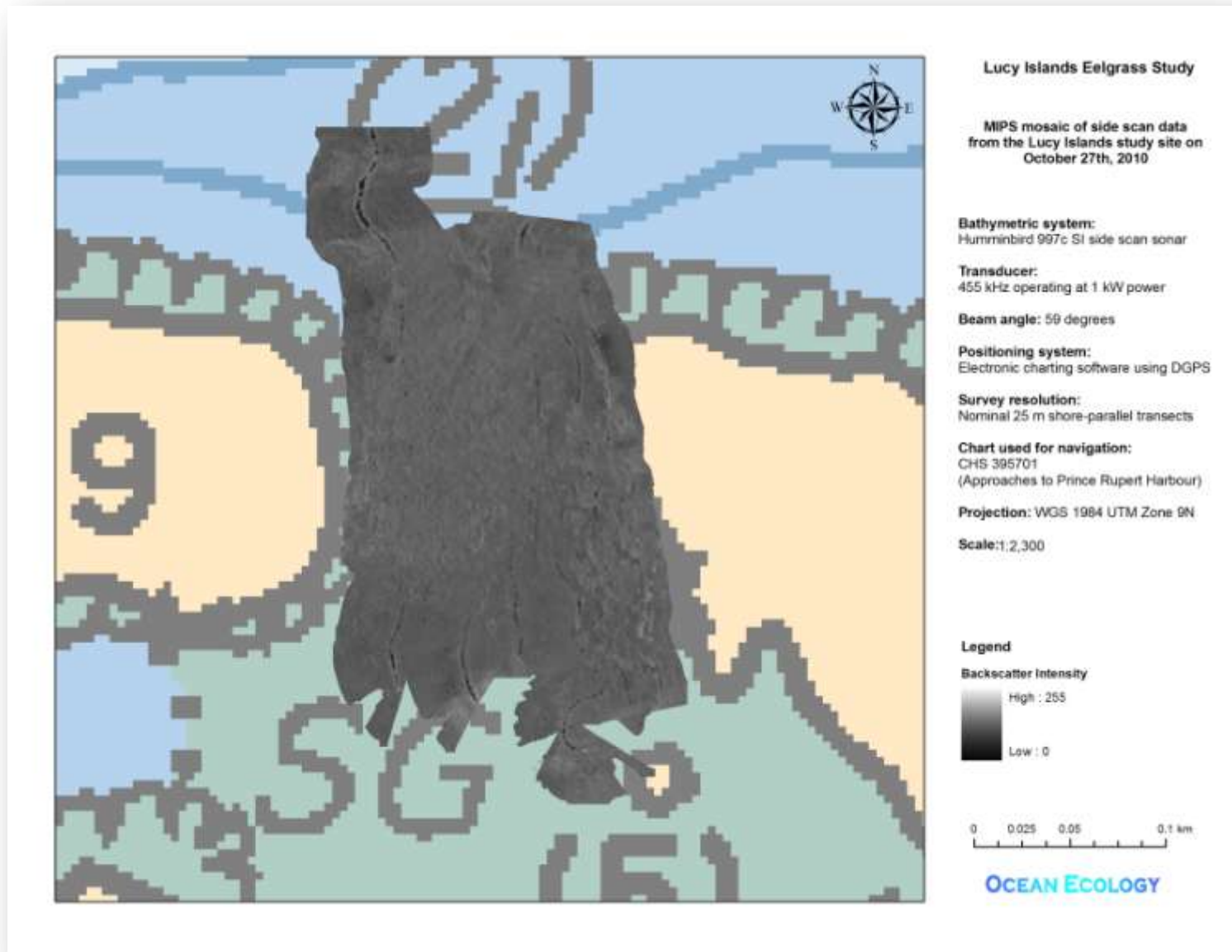

Figure 55. MIPS mosaic of side scan data from the Lucy Islands study site on October 27<sup>th</sup>, 2010.



Figure 56. MIPS mosaic of side scan data from the Lucy Islands study site on April 20<sup>th</sup>, 2011.



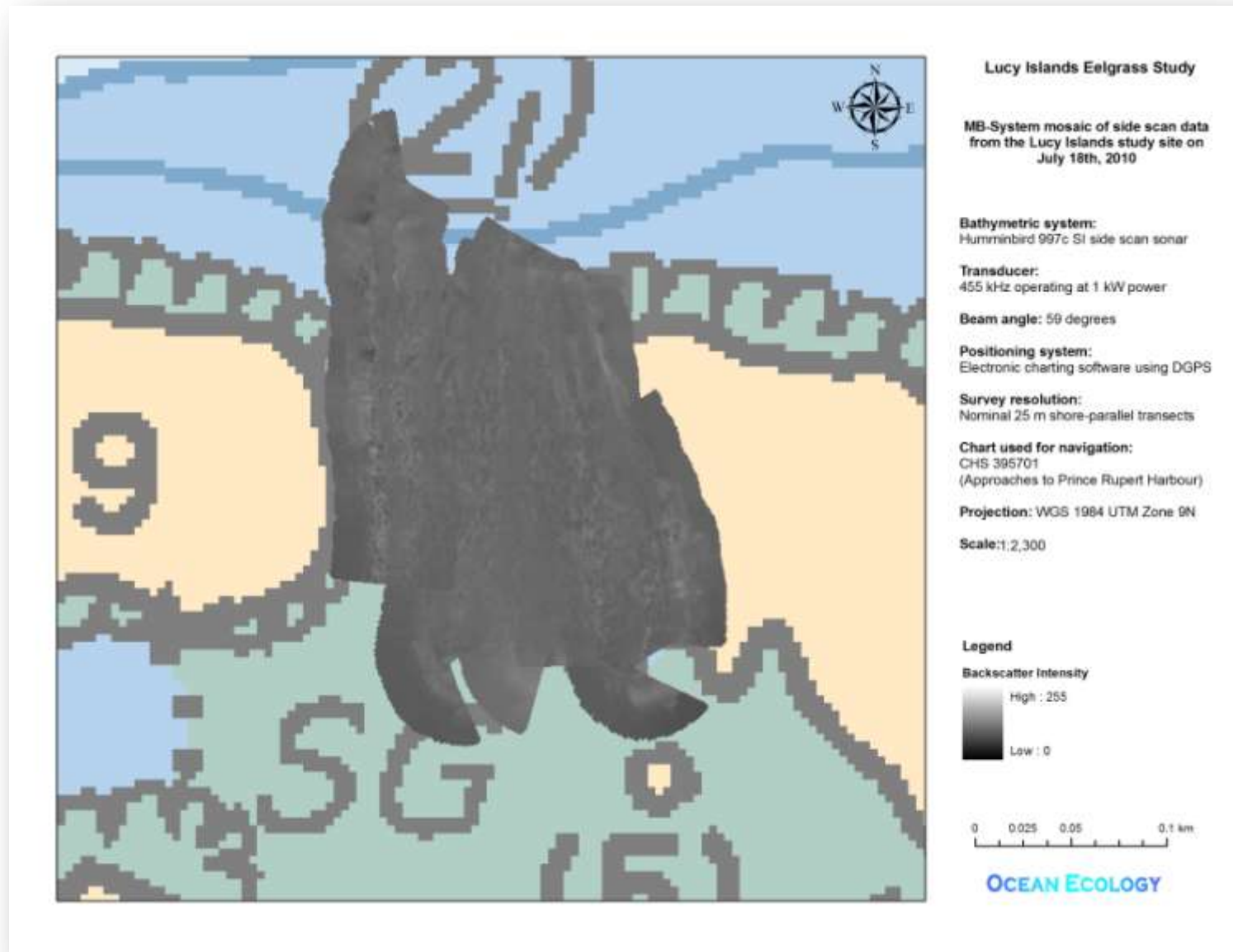

Figure 57. MB-System mosaic of side scan data from the Lucy Islands study site on July 18<sup>th</sup>, 2010.

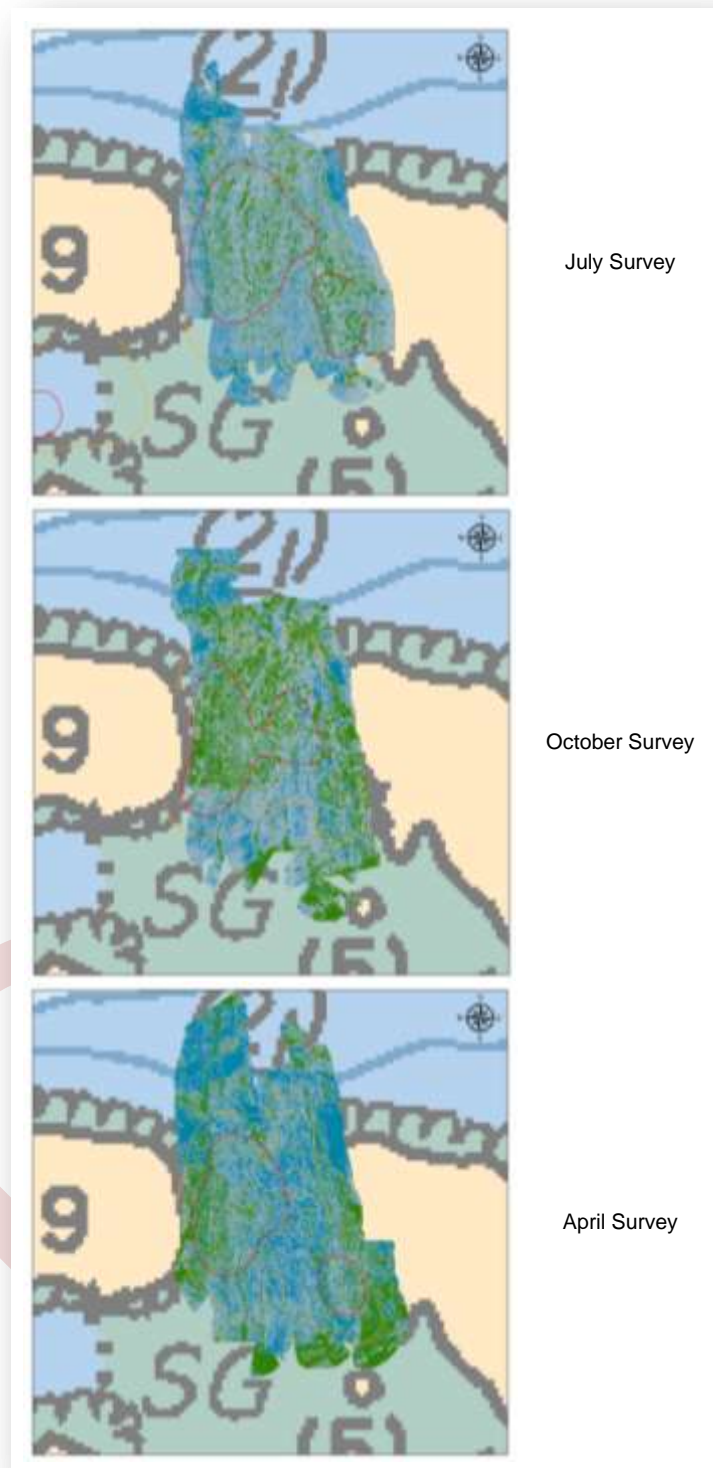

Figure 58. Overview of the temporal changes in eelgrass at the Lucy Islands study site as seen by MIPs processed side scan sonar with false-coloring.

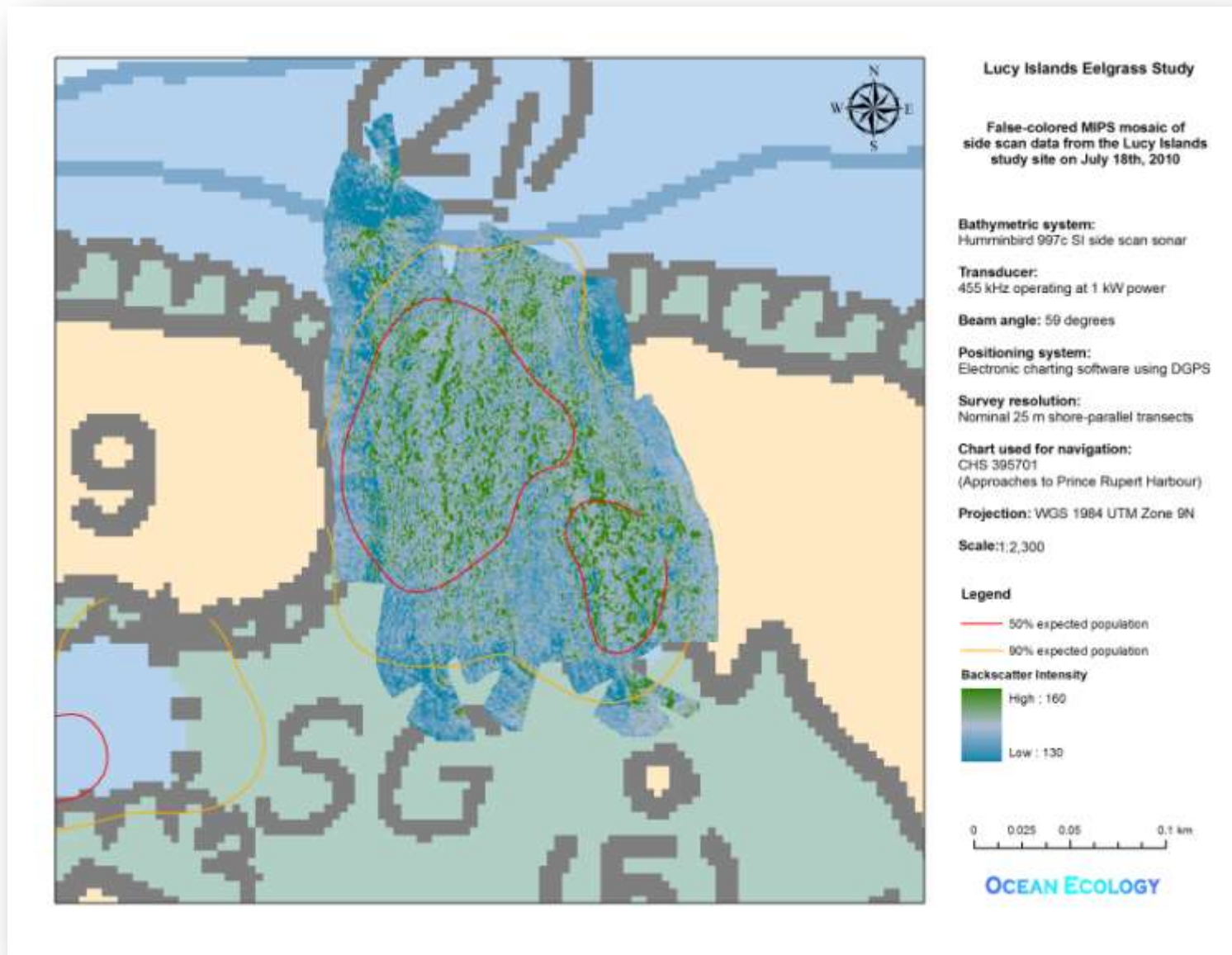

Figure 59. False-colored MIPS mosaic of side scan data from the Lucy Islands study site on July 18<sup>th</sup>, 2010.

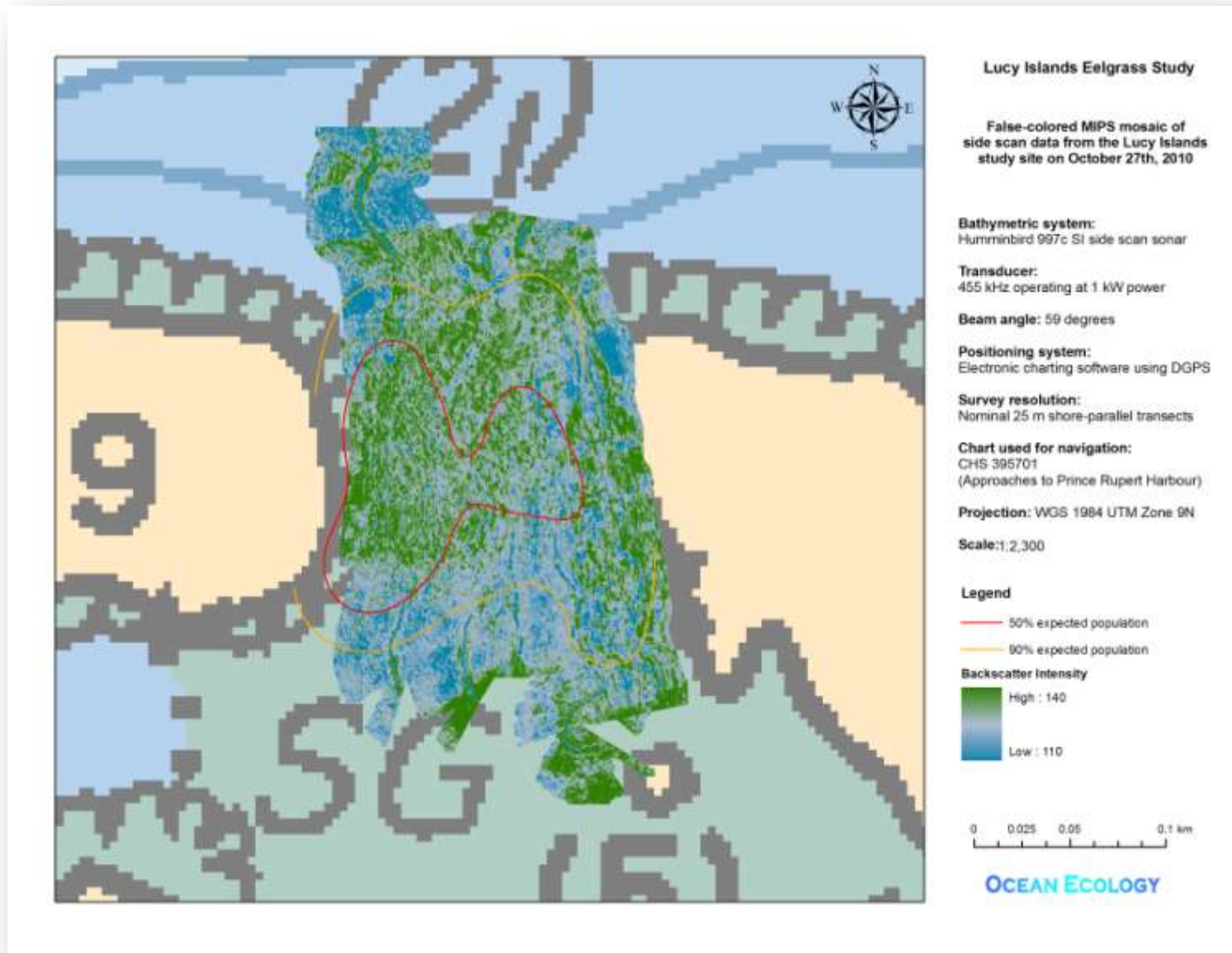

Figure 60. False-colored MIPS mosaic of side scan data from the Lucy Islands study site on October 27<sup>th</sup>, 2010.

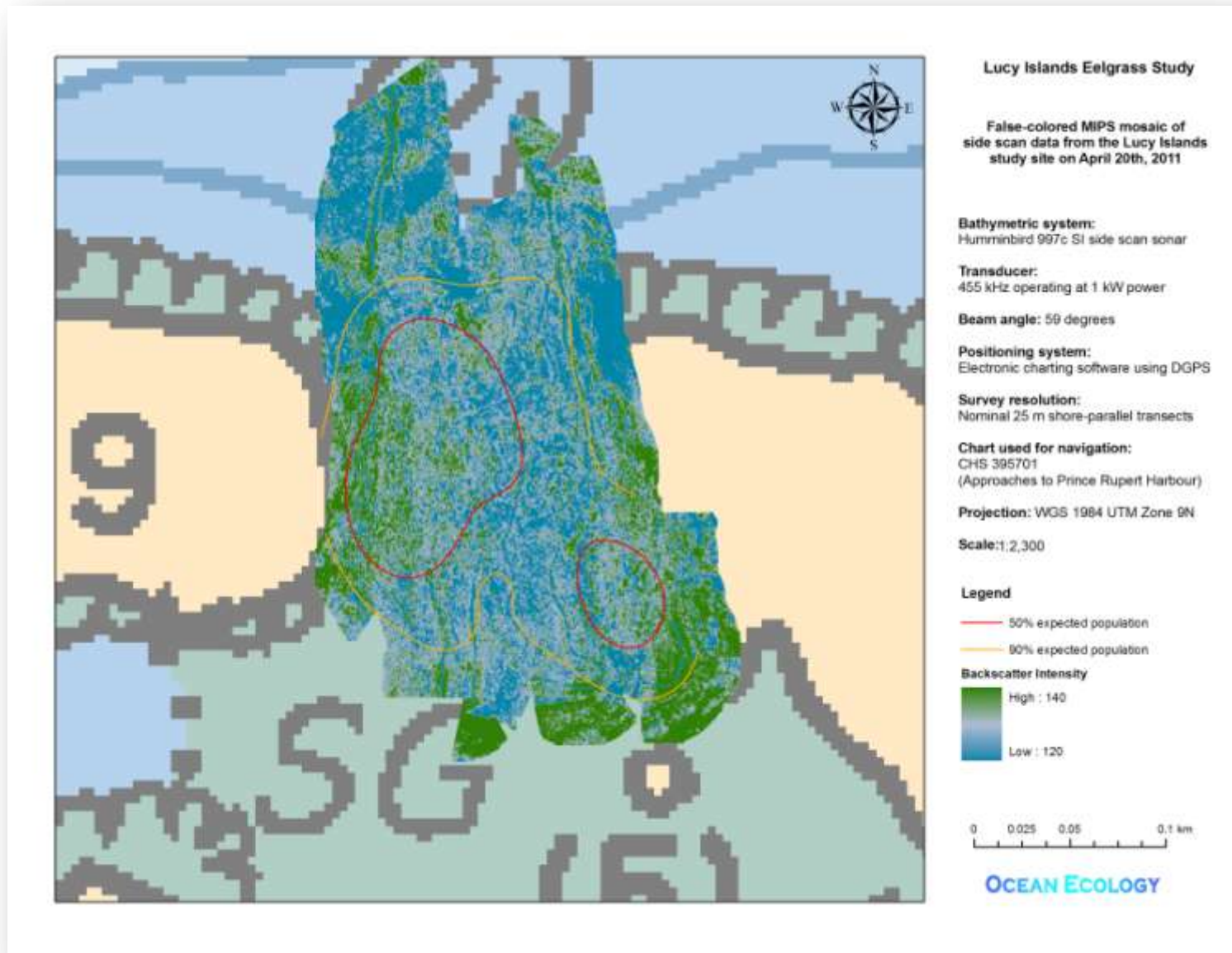

Figure 61. False-colored MIPS mosaic of side scan data from the Lucy Islands study site on April 20<sup>th</sup>, 2010.

### 3.5.5 *Bottom Hardness*

Bottom hardness values range from 0 for soft clay substrates to 8.0 for hard rock substrates. During the Lucy Islands study, the following ranges of hardness values were observed:

- July 18<sup>th</sup>, 2010 - bottom hardness values ranged from 3.0 to 5.8 (see Figure 63)
- October 27<sup>th</sup>, 2010 - bottom hardness values ranged from 3.7 to 6.0 (see Figure 64)
- April 20<sup>th</sup>, 2011 - bottom hardness values ranged from 3.4 to 6.0 (see Figure 65)

These values are consistent with substrates in the sand-pebble-cobble size range.

Based on this data, an interesting observation can be made regarding seasonal changes in substrate at the Lucy Islands site (see Figure 62). During July, a significant amount of softer substrate (denoted by the green areas in Figure 63) was observed in the region of the sandbar between the two islands. However, in the October survey, significantly less soft substrate was observed in the sandbar region (see Figure 64), and the entire seafloor of the site had become somewhat “hardened”. By April of the following spring, the substrate around the sandbar had “softened” again (see Figure 65). These observations can be explained by considering the mobility of sand at the site as follows.

1. During the fall and winter months, storms and wave heights (along with a general change in wave and wind direction) increase, and sand is eroded from the sandbar located at the center of the study site and transported offshore to form offshore sandbars. These offshore sandbars are probably located outside of the study site.
2. In the spring and early summer months, smaller, calmer waves dominate, and sand is transported back to the sand bar at the center of the study site from offshore.

This seasonal beach pattern is typical of exposed beaches.

The seasonal pattern of sand movement observed by the side scan sonar supports the visual substrate observations made during the towed video survey.

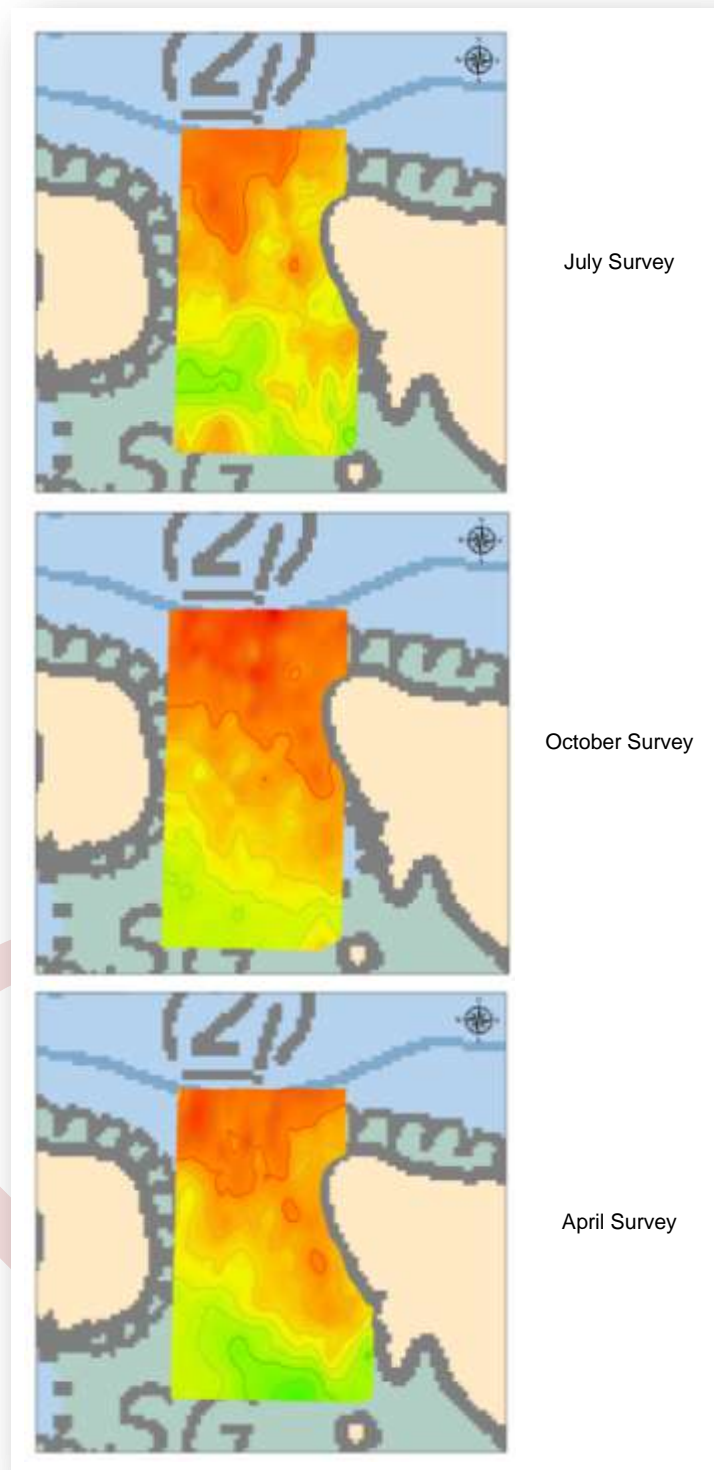

Figure 62. Overview of the temporal changes in seafloor hardness at the Lucy Islands study site.

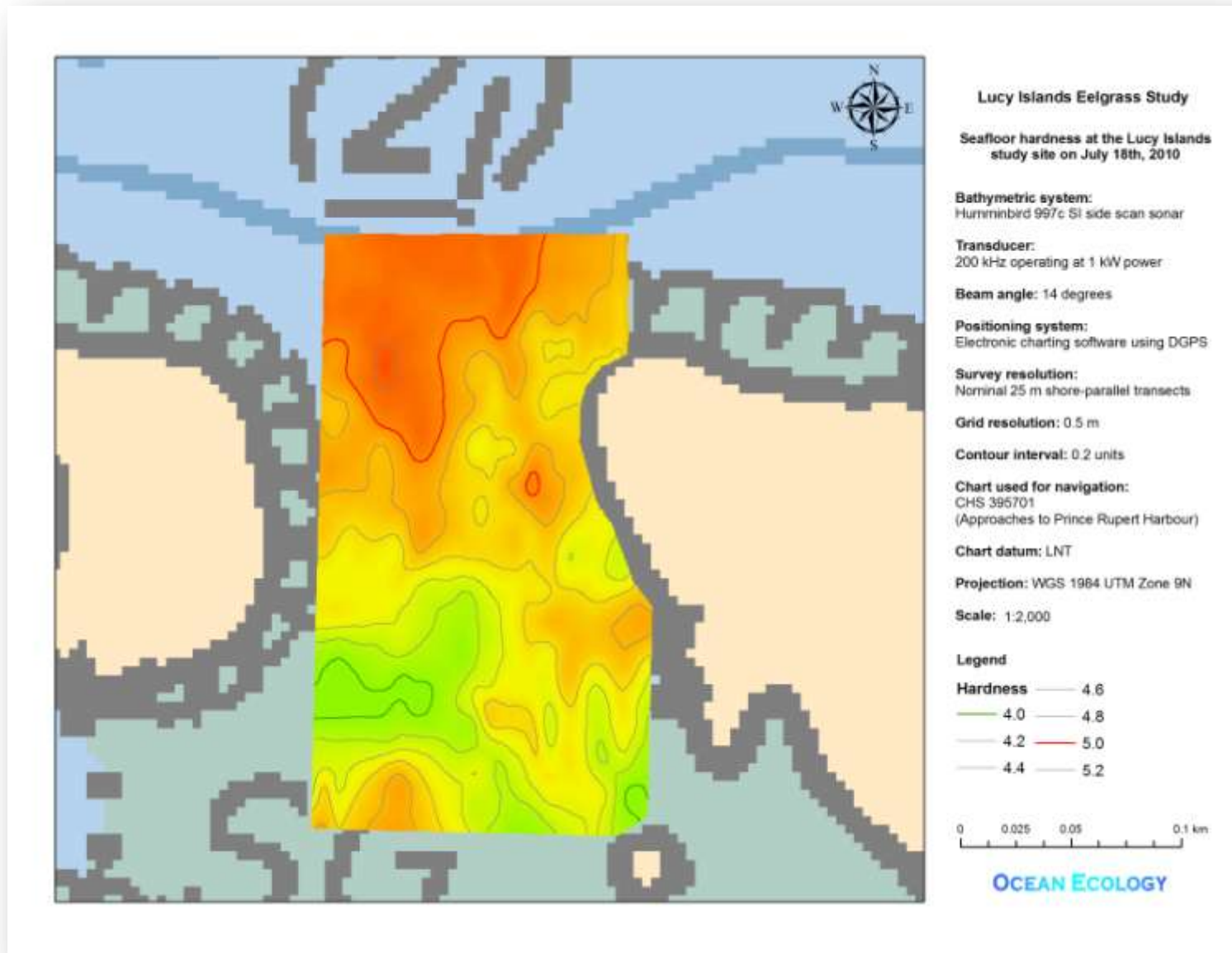

Figure 63. Seafloor hardness at the Lucy Islands study site on July 18<sup>th</sup>, 2010.



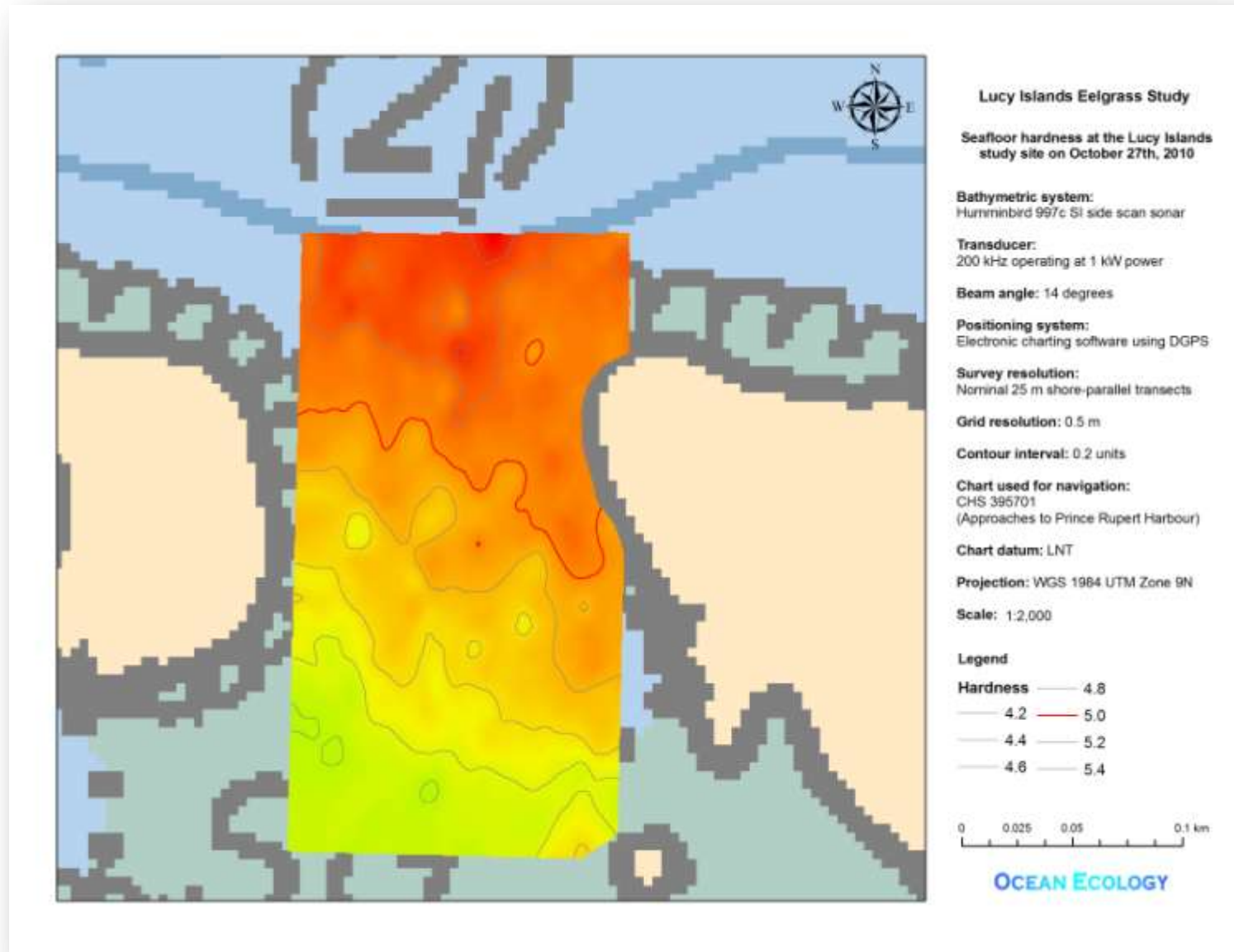

Figure 64. Seafloor hardness at the Lucy Islands study site on October 27<sup>th</sup>, 2010.

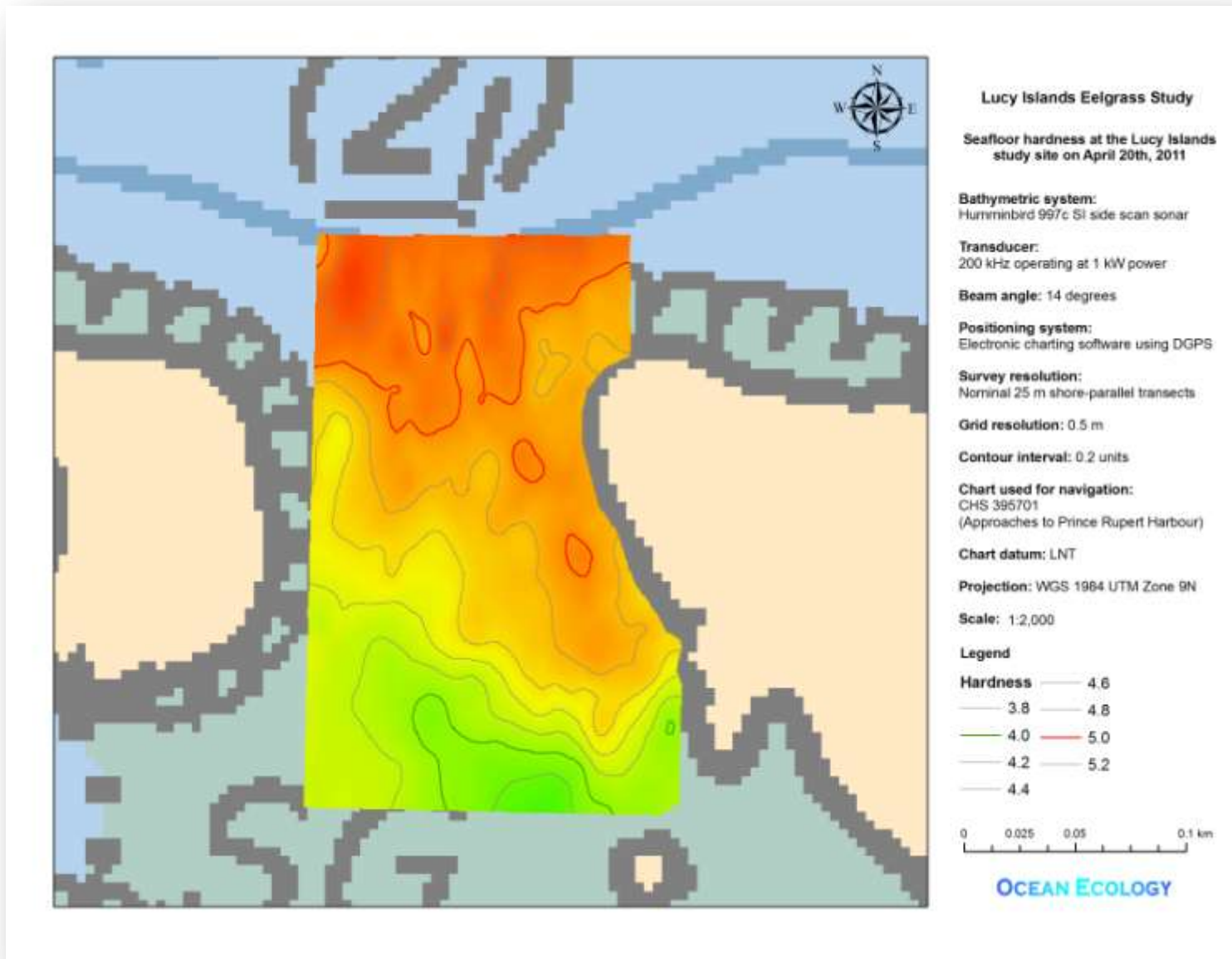

Figure 65. Seafloor hardness at the Lucy Islands study site on April 20<sup>th</sup>, 2011.

### 3.5.6 Calculation of Eelgrass Height

Macrophyte height at the Lucy Islands study site is shown in Figure 67 (July), Figure 68 (October), and Figure 69 (April). The algorithm for calculating macrophyte height does not differentiate between eelgrass and macroalgae. Therefore, it is not a good method for a preliminary survey of a site where the location of the eelgrass bed is unknown. However, once a bed has been located, this method could be used to track changes in eelgrass height, and thus productivity, throughout the year or over the course of several years.

In order to compare the vegetation height with the video data, the 50% and 90% expected population contours as determined from the video data are shown in Figure 67, Figure 68, and Figure 69. Except for the region around the rock at the north end of the site, there is very good correlation between the maximum vegetation height and the regions where the highest eelgrass populations are expected to be found. Around the rock at the north end of the site, vegetation height is probably dominated by kelps rather than eelgrass.

Temporal changes in eelgrass height were observed during the study (see Figure 66). Excluding the area around the northern rock, the seasonal variations in eelgrass height are shown in Table 7. Both the maximum and average eelgrass heights declined from July through to the following April. The probable cause of this decline in height was erosion of the eelgrass blades during the fall and winter storm events. In April, the eelgrass had not yet started significant growth; however, by July, extensive blade elongation had occurred.

Table 7. Temporal variations in eelgrass height.

Parameter	July 2010 survey number of observations	October 2010 survey number of observations	April 2011 survey number of observations
Maximum eelgrass height (m)	2.03	1.29	0.68
Average eelgrass height (m)	0.46	0.24	0.10

Another observation which can be made from the macrophyte height is the dominance succession pattern. In July, eelgrass is the dominant macrophyte, in terms of height, at the study site. However, in October and April, macroalgae, most likely kelps, are the dominant macrophytes, in terms of height, at the site.

One caution regarding the use of this methodology for macrophyte height measurement should be noted. Strong currents will cause benthic vegetation to lie flat along the seafloor. Measurement of macrophyte height under these circumstances would produce height values less than the actual blade lengths of the macrophytes. Thus, the optimal time for measurement of macrophyte height would be at slack water, preferable high tide in shallow water environments.

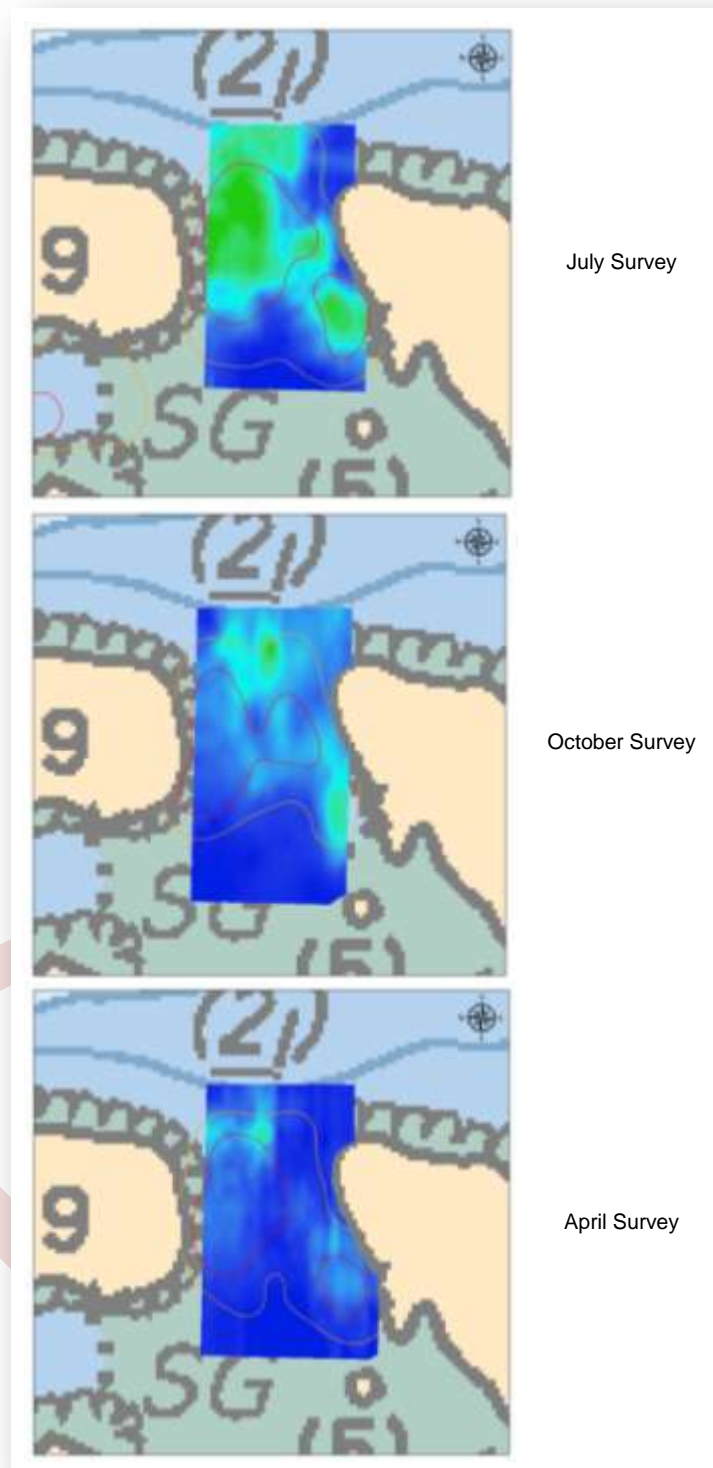

Figure 66. Overview of the temporal changes in macrophyte height at the Lucy Islands study site.

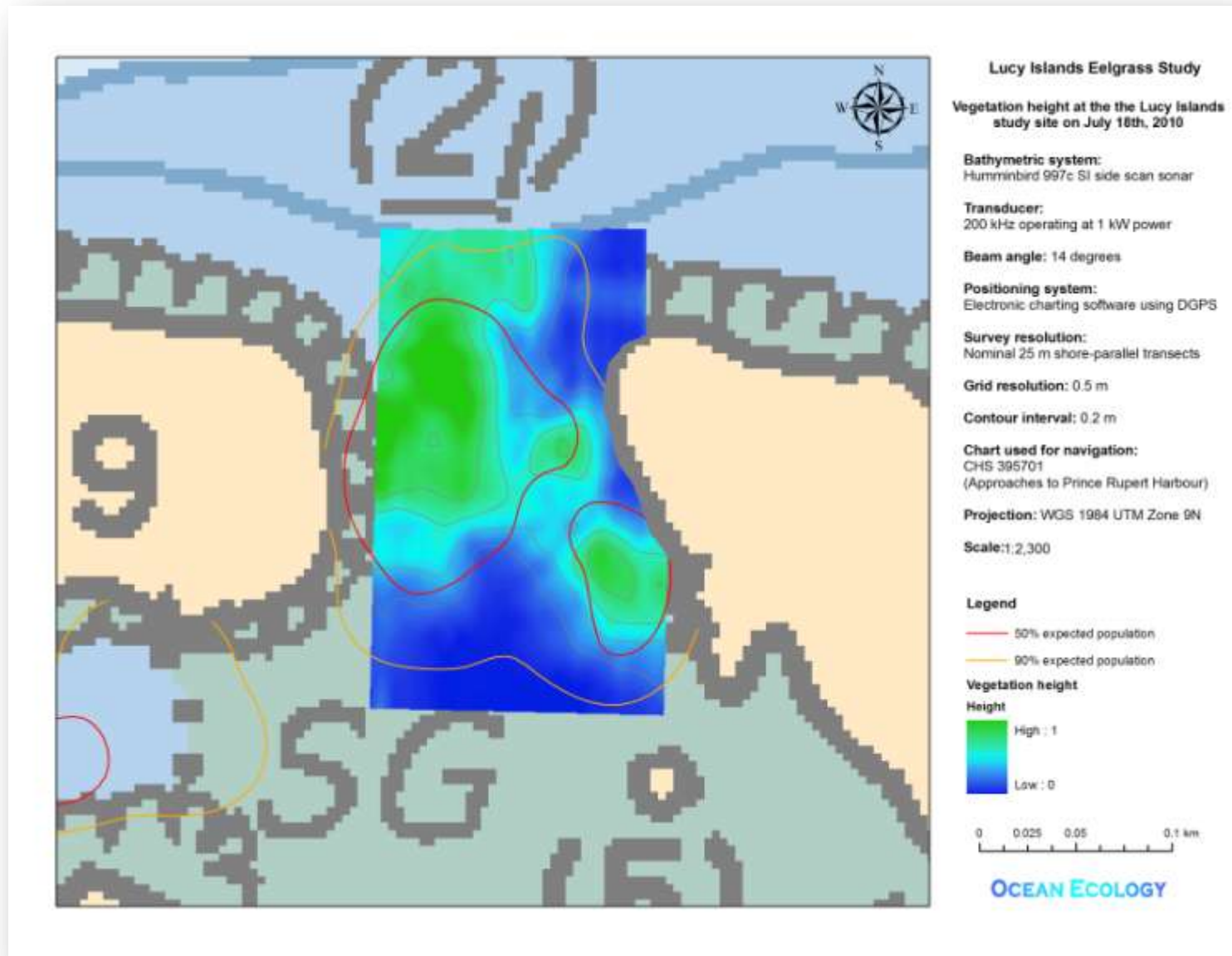

Figure 67. Vegetation height at the Lucy Islands study site on July 18<sup>th</sup>, 2010.

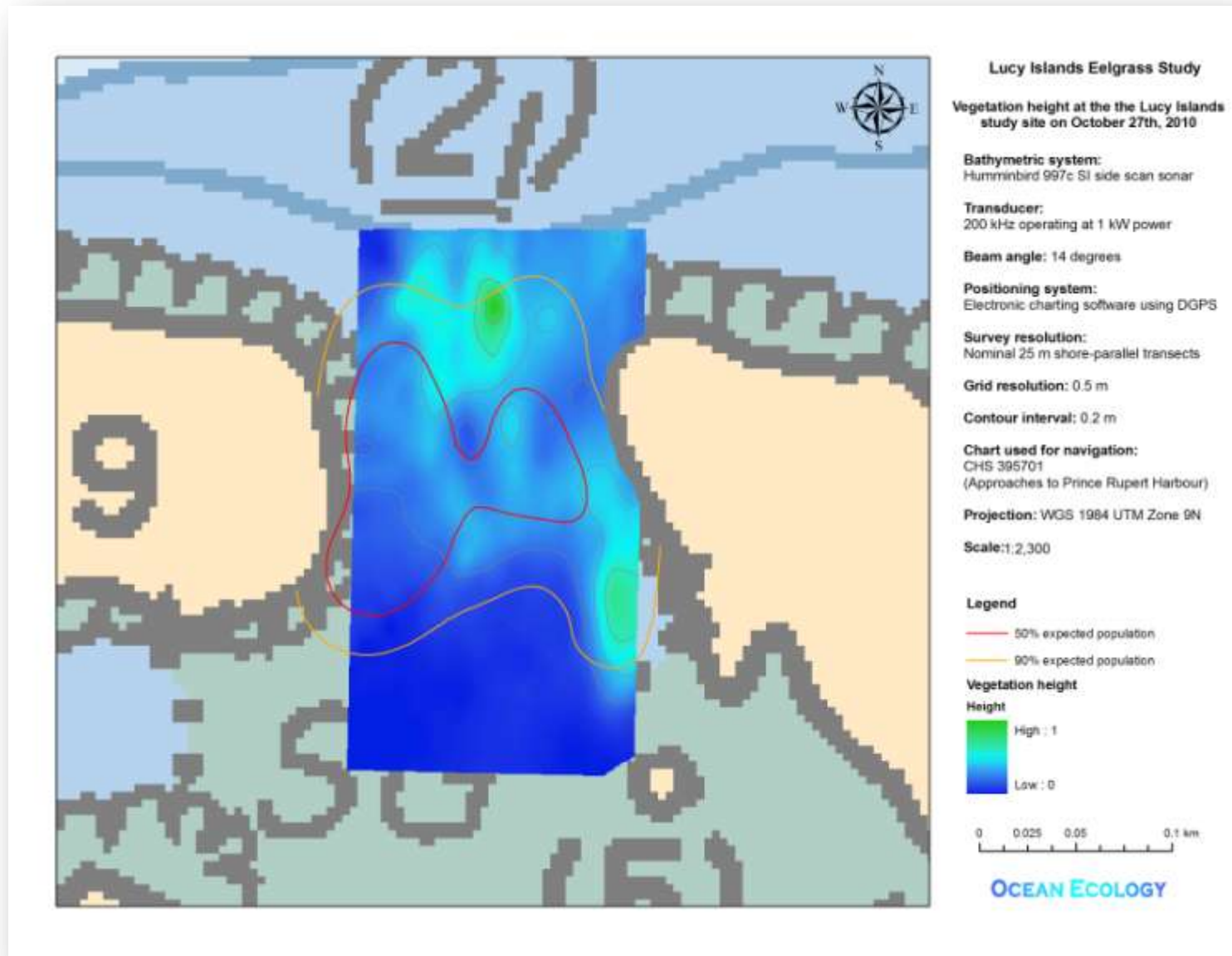

Figure 68. Vegetation height at the Lucy Islands study site on October 27<sup>th</sup>, 2010.

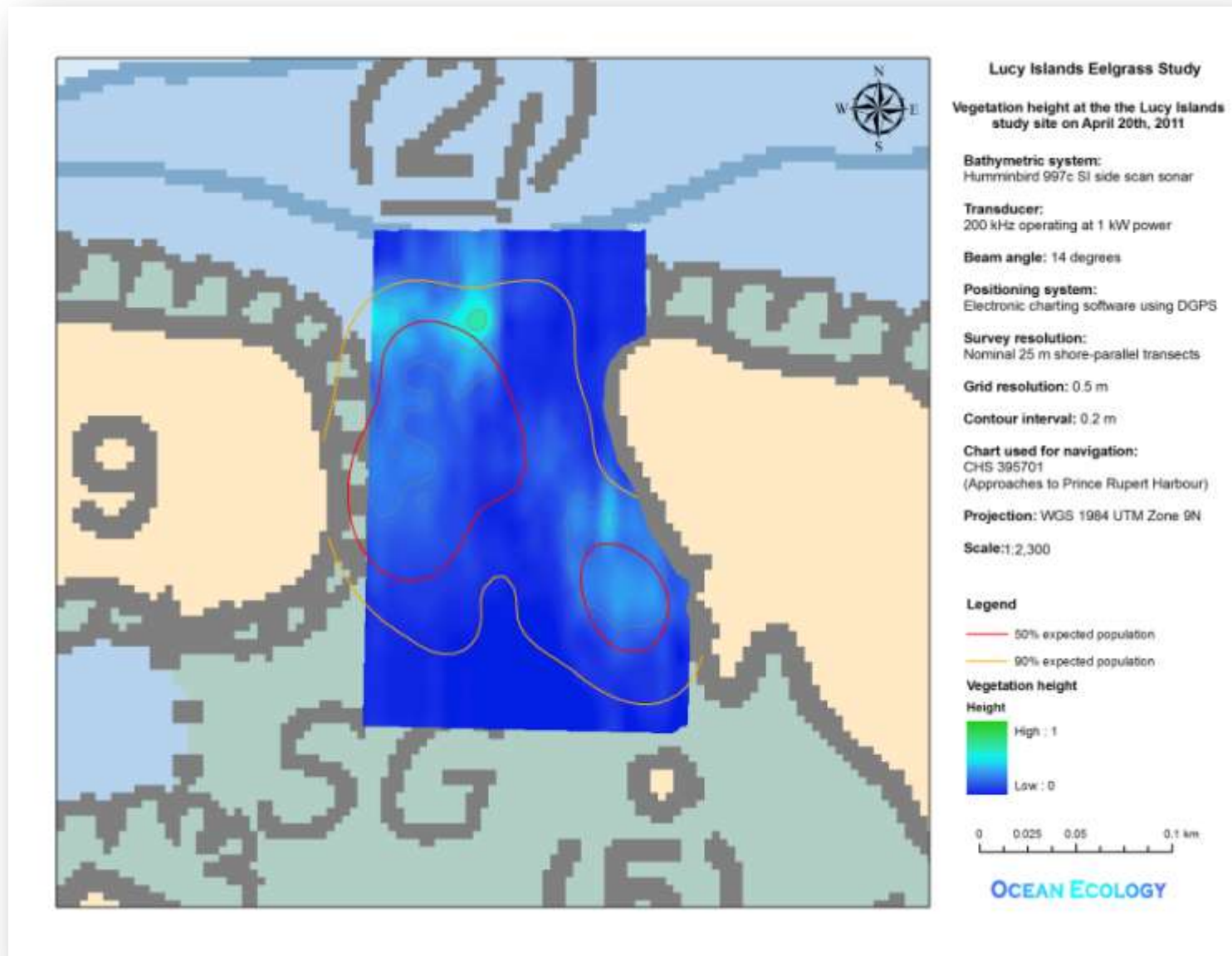

Figure 69. Vegetation height at the Lucy Islands study site on April 20<sup>th</sup>, 2011.

### *3.5.7 Macrophyte Height Profiles*

Profiles of the macrophyte height relative to the seafloor are shown in Figure 70 (east-west direction) and Figure 71 (north-south direction). Depths are relative to the lowest normal tide (LNT). Positive depth values are intertidal and negative depth values are subtidal. Mean water level is approximately 3.8 m for this location. Thus, positive depth values below 3.8 m are only exposed for short periods of time.

In Figure 70, the profile starts on the west side of the channel and finishes on the east side of the channel. Macrophytes, predominantly eelgrass in this profile, are highest at the sides of the channel and lowest at the center of the channel. Eelgrass height is greatest in July and declines through October to April. Greatest decline is seen in the center of the channel, where erosion of eelgrass blades from storm waves is the highest.

In Figure 71, the profile starts at the beach on the south side of the study site and finishes to the east of the rock at the north end of the site. Eelgrass height is lowest at the beach, and highest near the middle of the site. As with the previous profile, eelgrass height is greatest in July and declines through October to April.



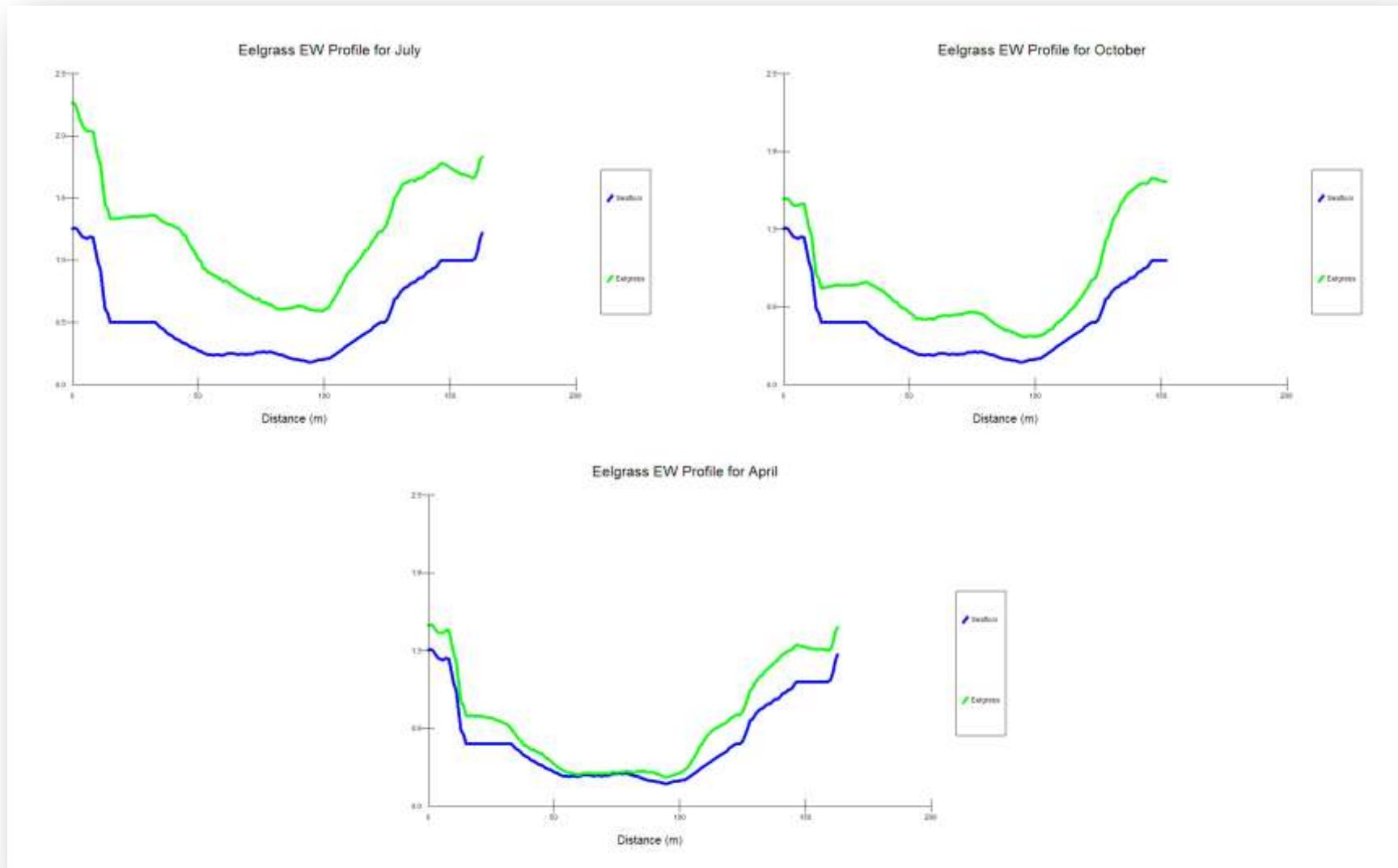

Figure 70. EW eelgrass profiles for the Lucy Islands study site.

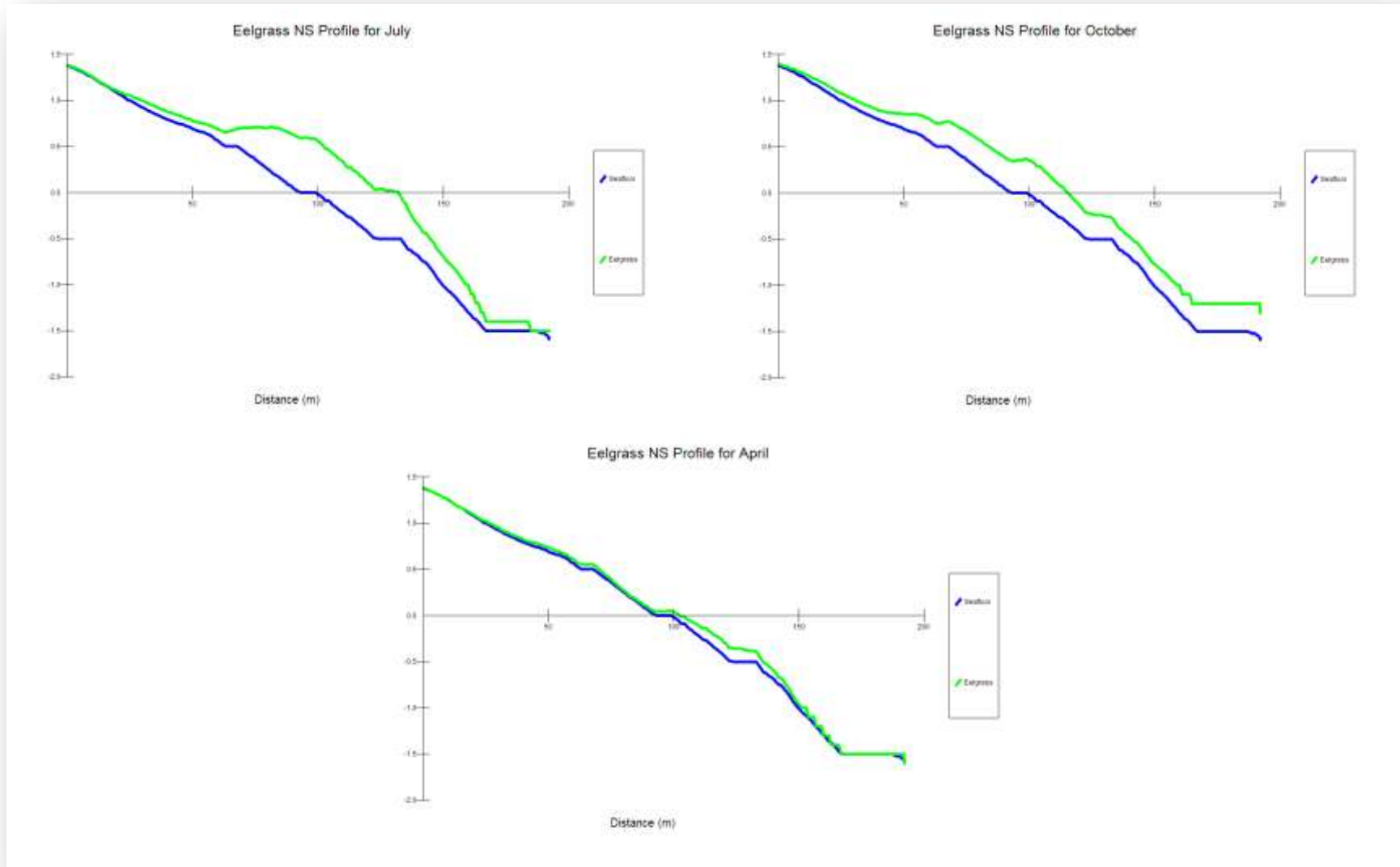

Figure 71. NS eelgrass profiles for the Lucy Islands study site.

### 3.5.8 *Observations of Anthropogenic Disturbances in the Eelgrass Bed*

While many human activities were clearly taking place at the study site, observations of anthropogenic disturbances of the eelgrass bed were relatively few, as shown in Figure 72. During the July survey, when the eelgrass was at its greatest abundance, no obvious scars were observed in the side scan sonar images. This may have been due to the lush eelgrass growth obscuring or hiding any anchor marks. Some pockmarking that may have resulted from anchors and other human activities was observed during the October and April surveys, when the eelgrass abundance was greatly reduced.

Examples of anthropogenic disturbances are shown in Figure 73 and Figure 74. In Figure 73, the piles used for the temporary dock that was present at the site during the October survey are seen, along with an associated drag mark, probably from chains or cables associated with the dock. Figure 74 shows a possible anchor pockmark seen during the April survey, and the corresponding video image taken from the same location. The video image clearly shows that the pockmark has much less eelgrass present than the surrounding areas.

Although the use of anchors in the eelgrass bed is clearly damaging to the eelgrass, resulting in loosening and uprooting of plants, it is likely that the seasonal migration of sand into and out of the site quickly removes any signs of damage.

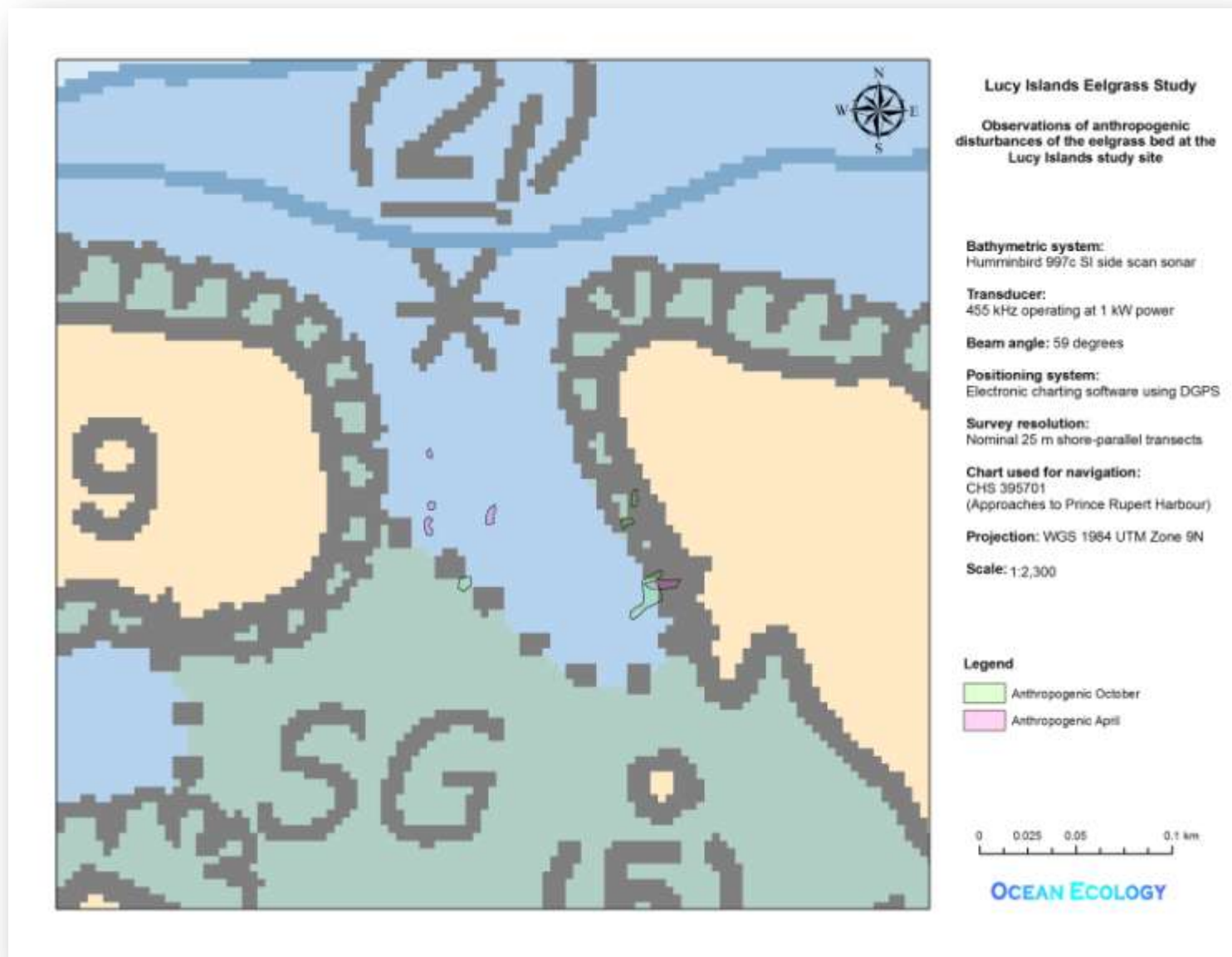

Figure 72. Observations of anthropogenic disturbances of the eelgrass bed at the Lucy Islands study site.

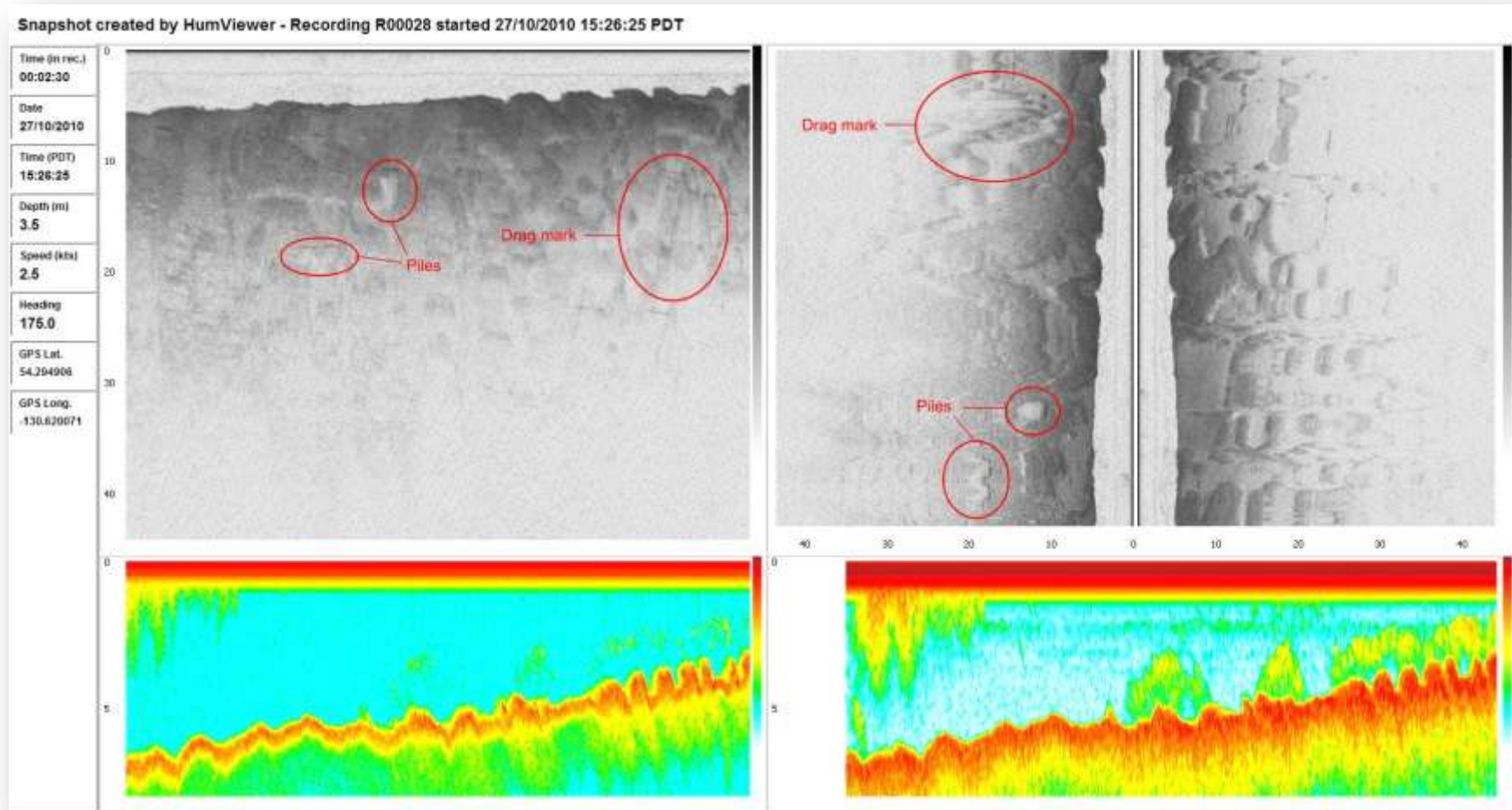

Figure 73. Raw side scan sonar image showing piles from the temporary dock structure present at the site during the October survey.

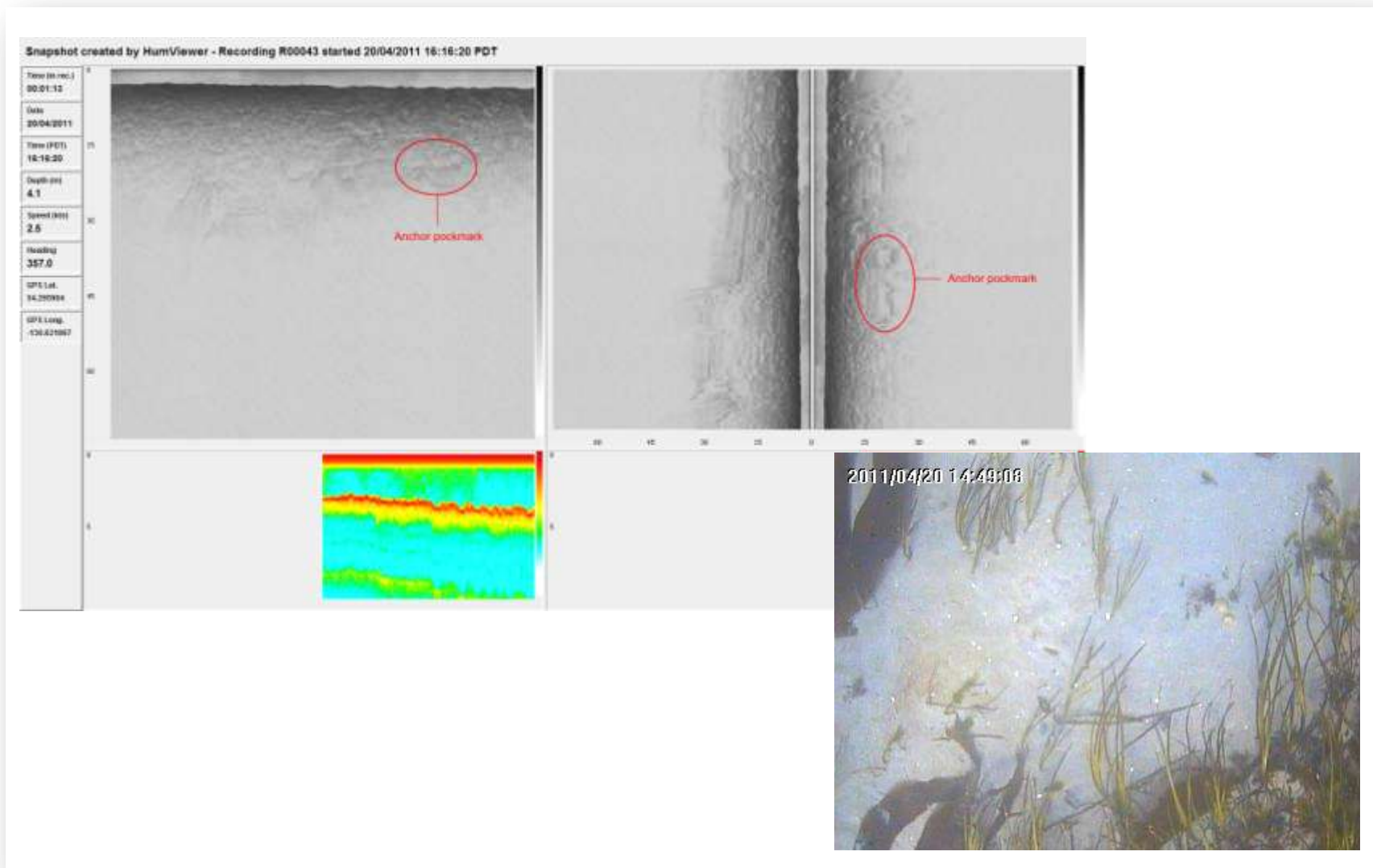

Figure 74. Anchor pockmark in a side scan image from the April survey (top) and the corresponding video image of the pockmark (bottom).

### 3.6 Multibeam Sonar Survey

Multibeam sonar is used to rapidly map large swaths of the seafloor. A typical multibeam sonar has anywhere from 6 to 120 beams angled so that each beam ensonifies a portion of the seafloor in a swath on both sides of the ship or towfish. The data from all the individual beams are processed to create a bathymetric map of the sea floor. Multibeam sonars are slightly less accurate than single-beam sounder systems because the individual beams strike the seafloor at an angle, and corrections must be made to calculate the true seafloor depth; however, they can cover much greater areas of the seafloor in a much shorter time than a single-beam sounder.

The bathymetry as derived from the multibeam data is shown in Figure 75. This can be compared to the bathymetry as determined from the single-beam sounder in Figure 22. Originally, it had been hoped that the multibeam sonar system would produce a more detailed bathymetry of the site, with the possibility of overlapping swaths and complete coverage of the entire seafloor. However, as it turned out, the single-beam sounder outperformed the multibeam sonar at the study site for the following reasons.

- Based on the geometry of the transducers in the Humminbird multibeam sonar unit, the total swath width, in meters is:

$$\text{Swath width} = 1.05H$$

where  $H$  is the water depth. Thus, even at the deepest part of the site (approximately 4.5 m), the swath width would only be 4.7 m. Given the difficulties of navigating at the site, the distance between multibeam transects was approximately 25 m; therefore there was no overlap between multibeam swaths.

- Given the narrow width of the multibeam swaths and the large gap between swaths, the multibeam sonar survey at the site was essentially the same as using a single-beam sounder.
- In the actual single-beam sounder survey that was carried out at the site, there were both shore-parallel and shore-perpendicular transects lines. Thus, the resulting resolution of the single-beam sounder survey in the shallow water at the Lucy Islands study site was greater than the multibeam sonar survey.

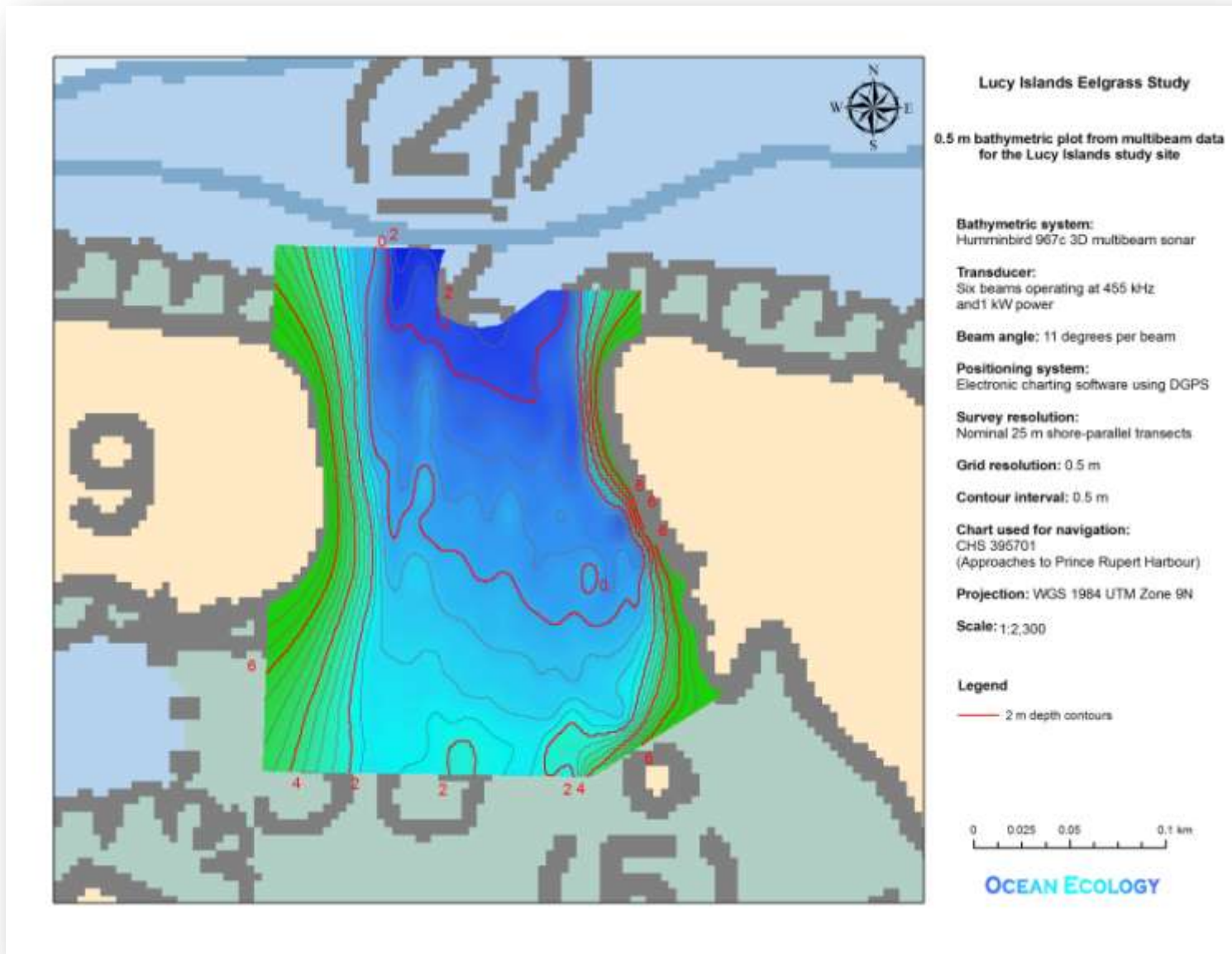

Figure 75. 0.5 m bathymetric plot from multibeam data for the Lucy Islands study site.



### 3.7 Beach Seining

A total of 16 species (8 fish species and 8 invertebrate species) were caught during beach seining at the Lucy Islands study site (see Table 8). Photographs of these species are provided in Table 19 of the Appendix.

Table 8. Faunal abundance and diversity from beach seines at the Lucy Islands site.

Species	July 2010 survey number of observations	October 2010 survey number of observations	April 2011 survey number of observations
Crescent gunnel ( <i>Pholis laeta</i> )			1
Penpoint gunnel ( <i>Apodichthys flavidus</i> )	4		1
Buffalo sculpin ( <i>Enophrys bison</i> )		5 (3 light coloration and 2 dark coloration)	
Fluffy sculpin ( <i>Oligocottus snyderi</i> )	1		
Tidepool sculpin ( <i>Oligocottus maculosus</i> )	44 (12 large and 32 small)		
Tube-snout ( <i>Aulorhynchus flavidus</i> )		1	
Pacific sandfish ( <i>Trichodon trichodon</i> )			1
Sand sole ( <i>Psettichthys melanostictus</i> )			1
Eelgrass isopod ( <i>Idotea resicata</i> )			7
Feather boa isopod ( <i>Idotea stenops</i> )		1	
Pale beach hopper ( <i>Megalorchestia columbiana</i> )			6
Blacktail shrimp ( <i>Crangon nigricauda</i> )		1	
Smalleyed shrimp ( <i>Heptacarpus carinatus</i> )			16
Stout shrimp ( <i>Heptacarpus brevisrostris</i> )			7
Threespine shrimp ( <i>Heptacarpus tridens</i> )			1
Graceful kelp crab ( <i>Pugettia gracilis</i> )			6
<b>Total observations</b>	<b>49</b>	<b>8</b>	<b>47</b>
<b>Total species</b>	<b>3</b>	<b>4</b>	<b>10</b>

Overall organism abundance was highest in July (49 observations) and April (47 observations), and lowest in October (8 observations). However, species richness showed a different trend - it was lowest in July (3 species) and October (4 species), and highest in April (10 species). Thus, during the summer, the intertidal regions of the site appeared to be dominated by large numbers of a relatively few species (e.g., tidepool sculpins), whereas during the spring, the intertidal regions of the site had a great deal more diversity. In the fall, both organism abundance and species numbers were small, probably in response to reduced food (less eelgrass, macroalgae, and phytoplankton) and increased storm activity making various niches less habitable.

During the July survey, the beach seine was set 4 times, whereas during the other surveys, only 3 sets were done. The first set of the July survey came up empty. This was attributed to inexperience in using the net, and the set was considered a practice set. Therefore, the fishing effort for all three of the surveys was essentially equal.

The level of the tide during the beach seining may also have had an impact on the abundance and diversity of the catches. Although all beach seining was done at the lowest possible tide, the levels of the tides did vary somewhat between surveys:

- July 18<sup>th</sup>, 2010 - low water was 1.99 m
- October 27<sup>th</sup>, 2010 - low water was 2.73 m
- April 20<sup>th</sup>, 2011 - low water was 0.18 m

Thus, there is something of a correlation between organism abundance and the height of the tide, with more organisms being caught during the lowest tides. However, species richness was not correlated with tide height. Due to the shallow nature of the beach at the site, it is recommended that future beach seine studies at the site use some variation of the parallel set method, where the seine net is fully deployed in a straight line by boat at a predetermined distance from shore and parallel to the shoreline (see Figure 76). This would ensure that the net could be deployed in sufficiently deep water that bias resulting from variations in low water levels could be avoided.

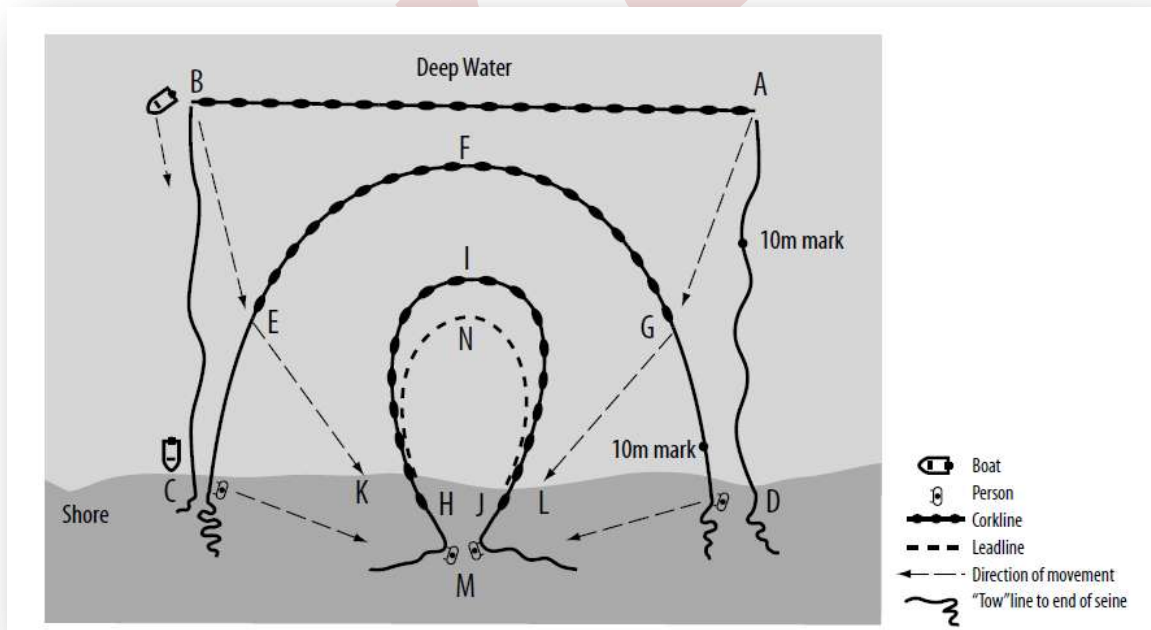

Figure 76. Parallel set deployment and retrieval of a beach seine (Hahn *et al.*, 2008).

During the beach seining surveys, the width of eelgrass blades caught in the net were measured, and were found to be approximately 8 mm in width. This suggests that the eelgrass in the lower intertidal zone of the Lucy Islands study site may be the *Zostera marina phillipsi* ecotype (found between 0 and -4 m with moderate tolerance to current; has intermediate blade length and width; Precision Identification Biological Consultants, 2002).

### **3.8 Bird Observations**

Observations of bird species richness and abundance were made around the Lucy Islands region (see Table 9). Three general areas were observed during the course of the study:

- the open water east of Lucy Islands
- the anchorage due south of the Lucy Islands' light house
- the study site

During the July survey, 11 species were observed. This dropped dramatically in the October survey to 1 species, and then increased to 13 species in the April survey. This is the same temporal pattern that was seen in the marine flora and fauna associated with the eelgrass bed. Clearly, whatever factors are affecting the productivity and diversity in the eelgrass bed are also having an impact on the local bird populations.

Although the Lucy Islands are a nesting site for rhinoceros auklets, none were seen feeding at the site during the study. Apparently, rhinoceros auklets feed out on the open ocean during the day, and deliver food to their nest sites largely by night. They may be seen coming into the inlets and islands at sunset during the summer (Vermeer, 1979). Two auklet carcasses, apparently raptor kills, were found on the main island during the July survey.

With the exception of the rhinoceros auklets, all the other observed bird species were engaged in feeding activities at the Lucy Islands. The pigeon guillemots, glaucous-winged gulls, bald eagles, common ravens, northwestern crows, and belted kingfishers were also nesting on the Lucy Islands.

Table 9. Bird abundance and diversity in the region of Lucy Islands.

Species	July 2010 survey observations	October 2010 survey observations	April 2011 survey observations
Common loon ( <i>Gavia immer</i> )			1 at the study site
Red-necked grebe ( <i>Podiceps grisegena</i> )			1 at the study site
Pelagic cormorants ( <i>Phalacrocorax pelagicus</i> )			3 at the study site
Rhinoceros auklets ( <i>Cerorhinca monocerata</i> )	Feeding in small groups (3 to 7 or so birds per group; probably "family clusters") on the open water east of the Lucy Islands		
Pigeon guillemots ( <i>Cephus columba</i> )	A few on the open water east of the Lucy Islands; 20-30 in family groupings with juveniles present and still flying up to the nesting ledges at the anchorage at Lucy Islands; some seen feeding at the study site		5 at the study site
Common murrelets ( <i>Uria aalge</i> )	A few on the open water east of the Lucy Islands		
Marbled murrelets ( <i>Brachyramphus marmoratus</i> )	2 at the anchorage at Lucy Islands		
Black turnstones ( <i>Arenaria melanocephala</i> )	6 at the anchorage at Lucy Islands		Small flock at the study site
Spotted sandpipers ( <i>Actitis macularia</i> )			One pair at the study site
Black oyster catchers ( <i>Haematopus bachmani</i> )	3 at the anchorage at Lucy Islands		2 at the study site
Harlequin ducks ( <i>Histrionicus histrionicus</i> )		One pair at the study site	One pair at the study site
Glaucous-winged gulls ( <i>Larus glaucescens</i> )	Numerous at the anchorage at Lucy Islands; very protective of a small islet just offshore of Lucy Islands (possible nesting site)		Numerous at the study site
Mew gulls ( <i>Larus canus</i> )			A few at the study site
Bald eagles ( <i>Haliaeetus leucocephalus</i> )	6 - 8 at the anchorage at Lucy Islands		Numerous at the study site
Common ravens ( <i>Corvus corax</i> )	4 at the anchorage at Lucy Islands		
Northwestern crows ( <i>Corvus caurinus</i> )	Numerous at the anchorage at Lucy Islands		4 at the study site
Belted kingfishers ( <i>Ceryle alcyon</i> )	One pair at the anchorage at Lucy Islands		One pair at the study site
<b>Total species</b>	<b>11</b>	<b>1</b>	<b>13</b>

### 3.9 Observations of Human Activities

The human activities observed at the Lucy Islands study site can be summarized as follows:

- July survey
  - On July 16<sup>th</sup>, the coast guard picked up an individual camped on Lucy Islands
  - During the period July 17<sup>th</sup> to July 19<sup>th</sup>, a small sport boat was anchored in the eelgrass bed at the middle of the study site. The boat came and went several times during this period. A camp was set up on shore, and several individuals were associated with the camp and boat.
- October survey
  - On October 27<sup>th</sup>, it was observed that a dock had been built at the study site by driving two piles into the sand offshore from the beach at the entrance of the Lucy Islands trail. A work boat was tied to the dock and a work crew was working on the trail.
- April survey
  - On April 20<sup>th</sup>, it was observed that the dock that had been built at the study site had been removed, along with the two piles. No other human activities were observed during that day.

Since the Lucy Islands Conservancy has a public access trail on the main island, boat traffic at the study site should be expected. Additionally, the Lucy Islands have long served as an anchorage and camping site for sports fishers and kayakers. In “Kayak Routes of the Pacific Northwest Coast”, the Lucy Islands are described as “[an excellent stopping-off point for kayakers paddling to or from Melville Island](#)” (McGee, 1998). Thus, the observed activities at the study site were not surprising, and probably comprised the normal types of human uses of the site.

### 3.10 Feasibility Study for Placement of Fixed Anchors

Whether from the dragging of a single anchor or anchor chain during a storm, or the repeated anchoring of boats at a popular recreational location, boat anchors can cause significant damage to seafloor habitats. To counter this, many MPAs have installed mooring buoys (Causey *et al.*, 2005). This has been particularly successful where protection of coral reef ecosystems is required (Project AWARE Foundation, 1996).

Permanent ecological moorings consist of a fixture on the seafloor, a floating buoy on the surface, and a line or cable to attach the two (see Figure 77). These systems enable boat users to tie off to an existing mooring rather than drop anchor, thus reducing the effect on the environment (Causey *et al.*, 2005).

A great variety of seafloor fixtures exist; however, only a few are recommended for use in a sand/pebble/cobble/eelgrass environment such as found at the Lucy Islands site. In sand, pebbles, and cobbles, either a helical screw anchor (a.k.a. sand screw or helix) or a dead weight mooring is the recommended solution. In eelgrass, either a helical screw anchor or a steel coil anchor is recommended (see Figure 78) (Francour *et al.*, 2006; Project AWARE Foundation, 1996). Traditional, simple systems (e.g., dead weight moorings) are best suited for shallow mud, sand, or gravel bottoms, and are not recommended for coral or seagrass areas (Project AWARE Foundation, 1996). Thus it would appear that the best choice of seafloor anchoring system for the Lucy Islands site would be a helical screw.

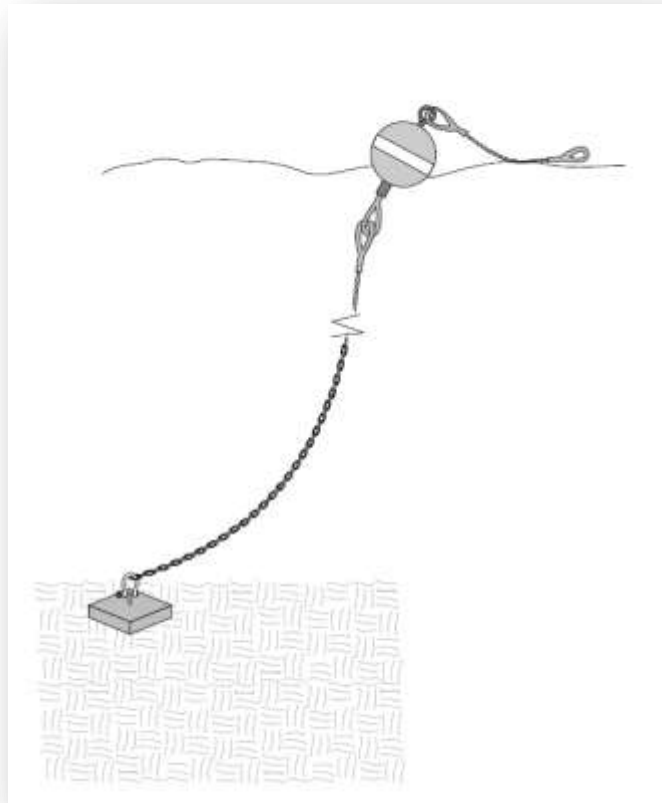

Figure 77. Traditional mooring buoy system (Project AWARE Foundation, 1996).

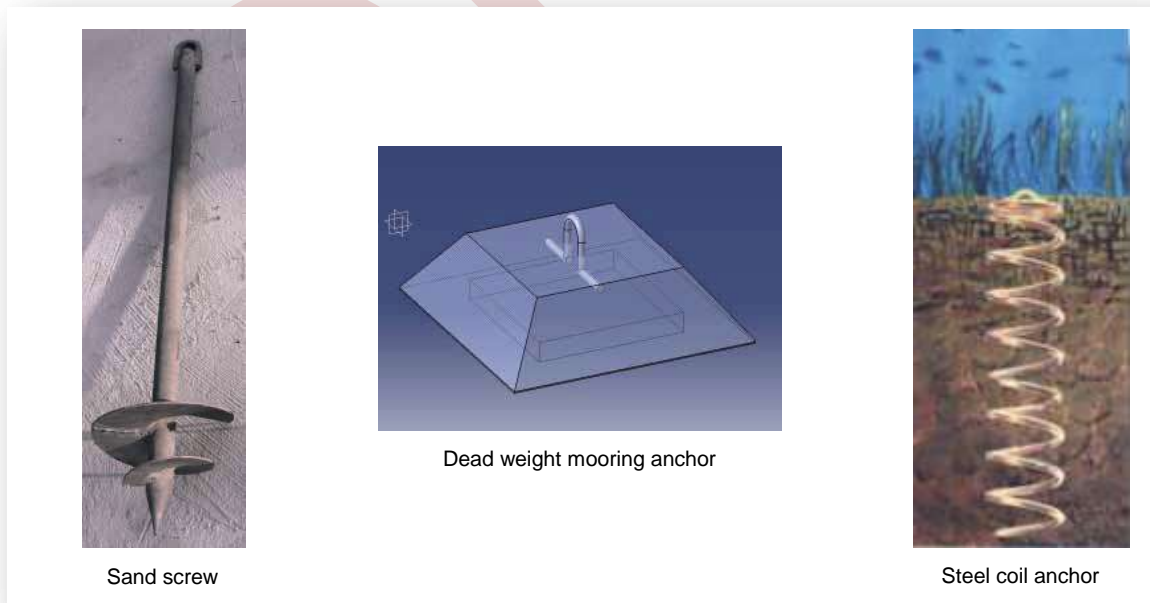

Figure 78. Possible anchoring systems which could be used at the Lucy Islands study site (Francour *et al.*, 2006).

Some of the benefits of helical screw anchors are (Project AWARE Foundation, 1996):

- They are versatile and have a high-load capacity.
- Their holding power cannot be equaled by traditional mushroom anchors or deadweight blocks.
- They maintain their holding power even with the shorter scoping necessary in congested harbors.
- They stay where they are put, and are friendlier to harbor bottom environments.

Unlike weight-dependent anchors, the holding power of embedment type anchors (e.g., helical screws) appears not to be affected by the angle from which they are pulled. Therefore, the strength of other mooring system components, like the hardware, rode (the line - chain, nylon or steel cable - used to hold the buoy fast to the anchor), and pennant (the line or chain by which a vessel is made fast to a mooring buoy), dictate the amount of scope (length of anchor line) required (see Figure 79). The helical screw anchor will take a load of over 9,400 kg before pulling out, whereas a 2,700 kg concrete block can be dragged by a load of 1,500 kg (Project AWARE Foundation, 1996).

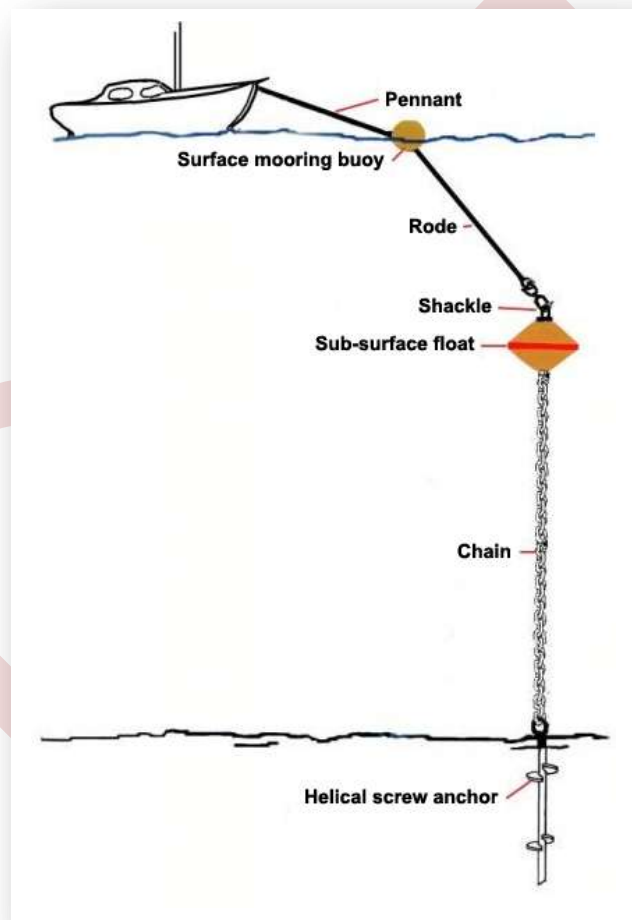

Figure 79. Example of a helical screw anchor system.

One of the problems associated with a traditional anchoring system is the destructive impact of the mooring line on the environment due to the incessant sweeping of the chain on the sea floor (see Figure 80) (Francour *et al.*, 2006). This issue can be solved by adding additional intermediary elements to the mooring systems or developing novel mooring systems (see Figure 81), but this also increases both the cost of the initial deployment of the system and the cost of subsequent maintenance.

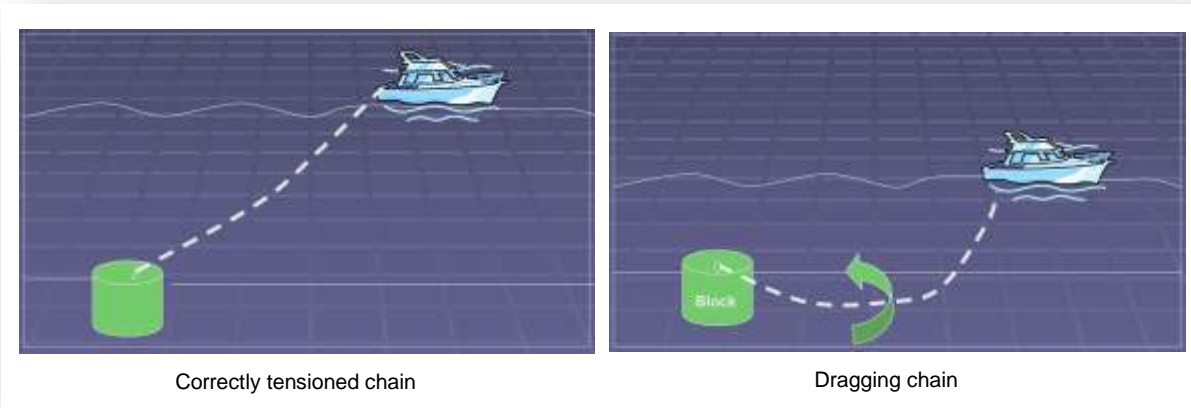

Figure 80. Destruction of benthos resulting from a dragging chain on a mooring buoy (Kendall *et al.*, 2005).

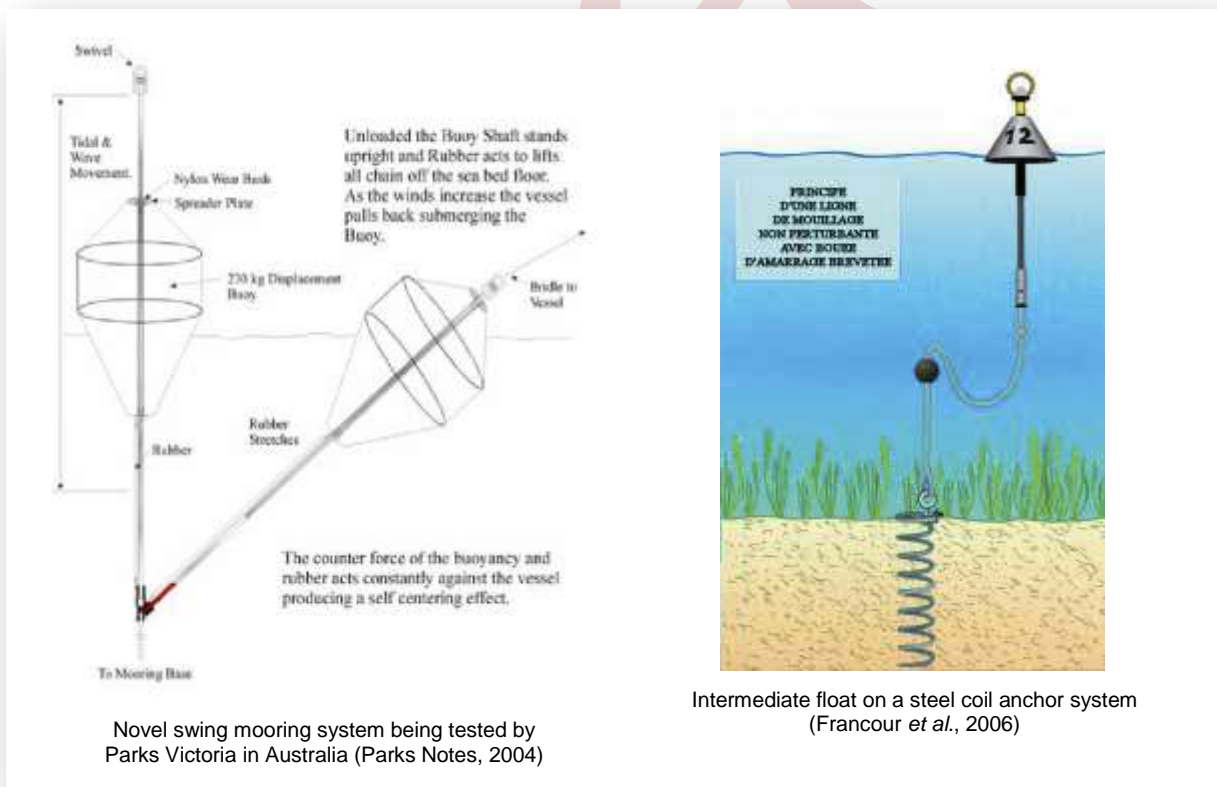

Figure 81. Examples of mooring systems which prevent the mooring chain from dragging through the benthos.



Another possible approach to providing fixed mooring for recreational users would be to install a single steel mooring pile at the site, and equip the piling with a floating collar to which boats could tie (see Figure 82). Although the driving of a pile may be somewhat more damaging to the eelgrass than the placing of a helical screw anchor, it would be a better alternative than the traditional deadweight anchoring system, and may be worth considering if the hardware to set up a helical screw anchoring system is not readily available.

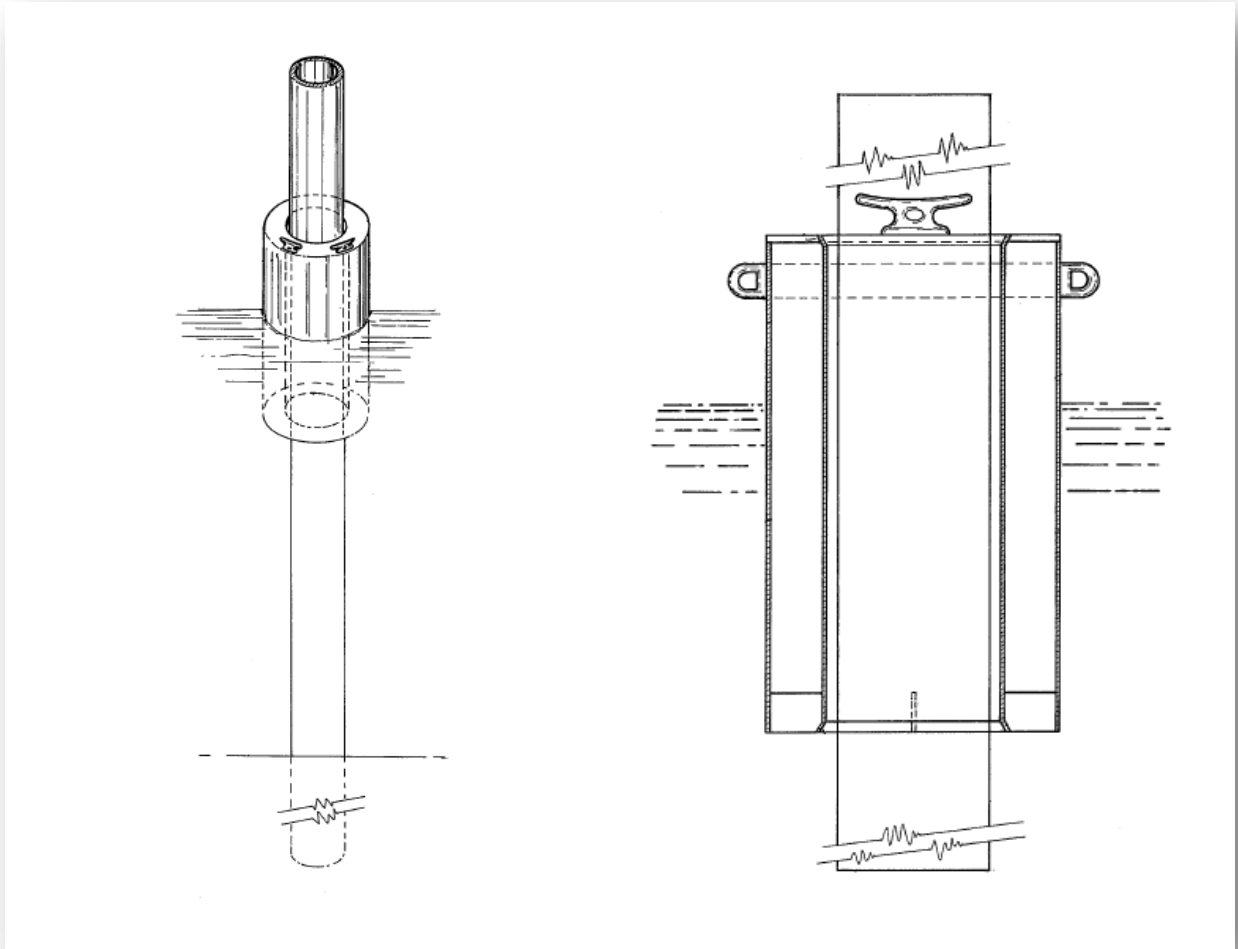

Figure 82. Example of a mooring pile with a floating collar (Sluys, 1982).

Some rough estimates of the costs to install a fixed anchorage system at the Lucy Islands site are provided below. The actual costs may vary significantly as a result of changes in the costs of materials and availability of supplies in Prince Rupert. These estimates do not include taxes or the cost to mobilize the contractor's equipment to the site.

*Option 1: Helical screw anchor system (see Figure 83)*

- Helical mooring anchor with double helixes (8"/10") = \$500
- 2 x  $\frac{3}{8}$ " screw-pin shackles = \$6
- 1 x  $\frac{5}{8}$ " screw-pin shackle = \$4
- 3 x  $\frac{3}{8}$ " thimbles = \$3
- Jaw-eye swivel = \$8
- Line weight = \$5
- 3 x 5" floats = \$15
- 50' of  $\frac{3}{8}$ " three-strand polypropylene rope = \$6
- Can-style regulatory buoys = \$200
- Anchor installation = \$250 - \$500

**Total** = \$997 - \$1247

*Option 2: Steel piling with float collar*

- 30' tubular steel 8" diameter piling with white epoxy coating @ \$55/foot = \$1650
- Floating collar for pile = \$470
- Pile driving = \$500 - \$1000

**Total** = \$2620 - \$3120

Thus, the cost of the helical screw anchor system is much less than using a steel piling with a float collar. However, availability of helical screw anchors in Prince Rupert may be a problem, as well as finding a contractor with experience in installing these anchors.

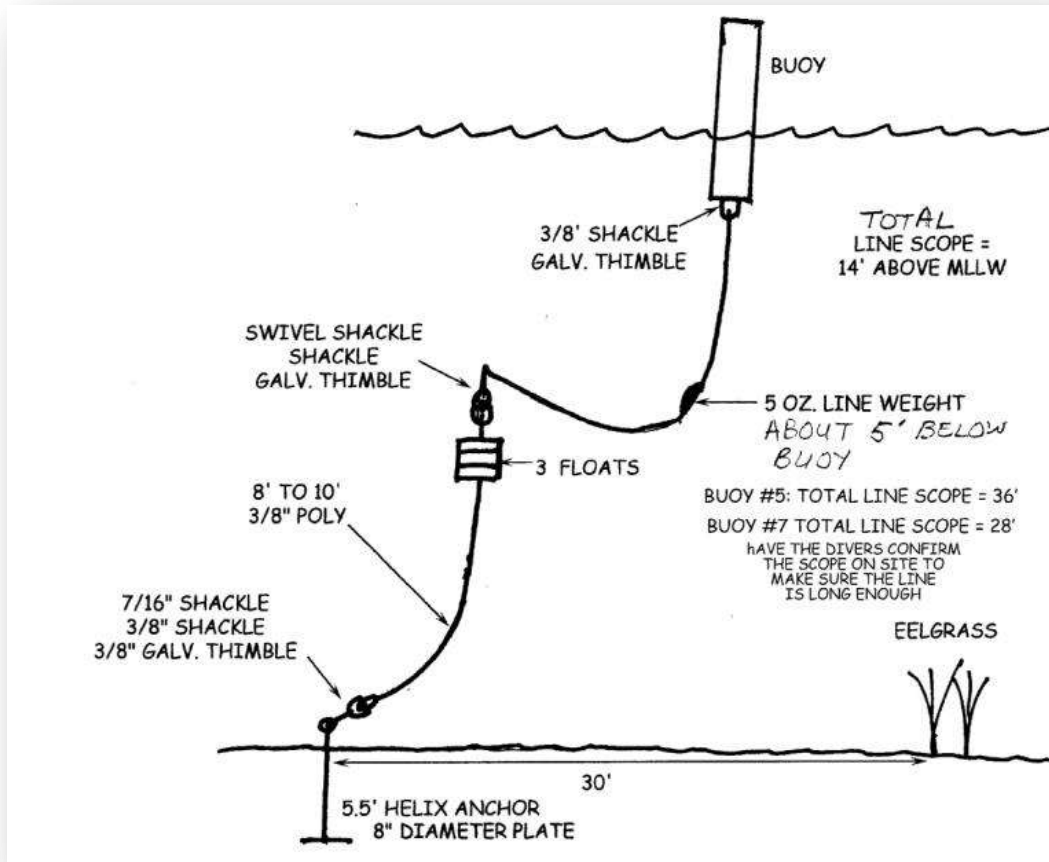

Figure 83. Tackle system for a helical screw anchoring system (JCMRC Eelgrass Protection Work Group, 2010).

Locating a fixed mooring in an MPA or a Conservancy must always be a balance between protecting the environment and respecting human patterns of usage at the site, many of which may have existed prior to the establishment of the MPA or Conservancy status. There is no “perfect” location for a fixed anchoring system at the Lucy Islands study site. To select a good candidate location, one must consider the following:

- Keep damage to the eelgrass beds to a minimum. Eelgrass occurs throughout the site; however, it is thicker and more abundant in some areas than others. Therefore, it would make sense to locate the fixed anchoring system away from the regions of densest eelgrass.
- Avoid regions of highest diversity.
- Locate the mooring in an area that does not dry at extreme low tides.
- Locate the mooring such that it has the greatest protection from prevailing winds. Many local fishers anchor at this site because it is protected, and for safe marine travel along the north coast, this feature should be respected.
- Locate the mooring so that it provides good access to the Lucy Islands trail. Mooring buoys need to be placed where boat users already prefer to go. To install a mooring where the parks’ managers want the vessels to go, instead of where the users will go, is wasteful (Causey *et al.*, 2005).

Based on the above considerations, Figure 84 shows the region of the Lucy Islands study site which best fits all the criteria.

The main challenge of mooring buoy systems is money - it costs money both to install the moorings and to maintain them (Causey *et al.*, 2005). The following are some approaches which have been taken by various organizations worldwide to fund mooring buoy systems:

- Oceanwatch, a conservation group in south Florida, has an “adopt-a-mooring buoy” program to which individuals or businesses can donate funds for the purchase and installation of a mooring buoy. A piece of the drilled core sample is given to the sponsor, or the donor is acknowledged with a special marking on the buoy itself (Project AWARE Foundation, 1996).
- The Marine Conservation Society Seychelles (MCSS), an NGO, is working to create a national mooring fee system in association with charter yacht operators, an expanding and profitable sector of the Seychelles tourism industry with more than 120 boats. Under the MCSS proposal, an additional 80 mooring buoys would be installed for charter boats’ use. Installation and maintenance would be paid for through a weekly mooring-use fee per boat, payable in advance by the charter companies and passed on to their clients (Causey *et al.*, 2005).
- Collecting fees for the use of mooring buoys can be included in the park management plan. Collection usually becomes a responsibility of the park warden, or collection can be contracted to a concessionaire. The amount of the fee would depend on the type of use of the mooring. In some areas an overnight mooring requires a \$10 fee. In areas where daily mooring buoy use is more common, boats are asked to donate \$1 per person (Project AWARE Foundation, 1996).

Ultimately, a management plan must be developed that clearly indicates in which areas anchoring is allowed, and in which areas a mooring buoy is present and must be used. In order for compliance with mooring buoy regulations to be successful, adequate funding must be available for regular boat patrols. Regulations should be clear and consistent, and the enforcement officer should be prepared to serve as an extension for an education program that helps users understand the purpose and value of the mooring buoy system. An effective education program will aid enforcement by encouraging proper use of mooring buoys and compliance with resource protection regulations (Project AWARE Foundation, 1996).

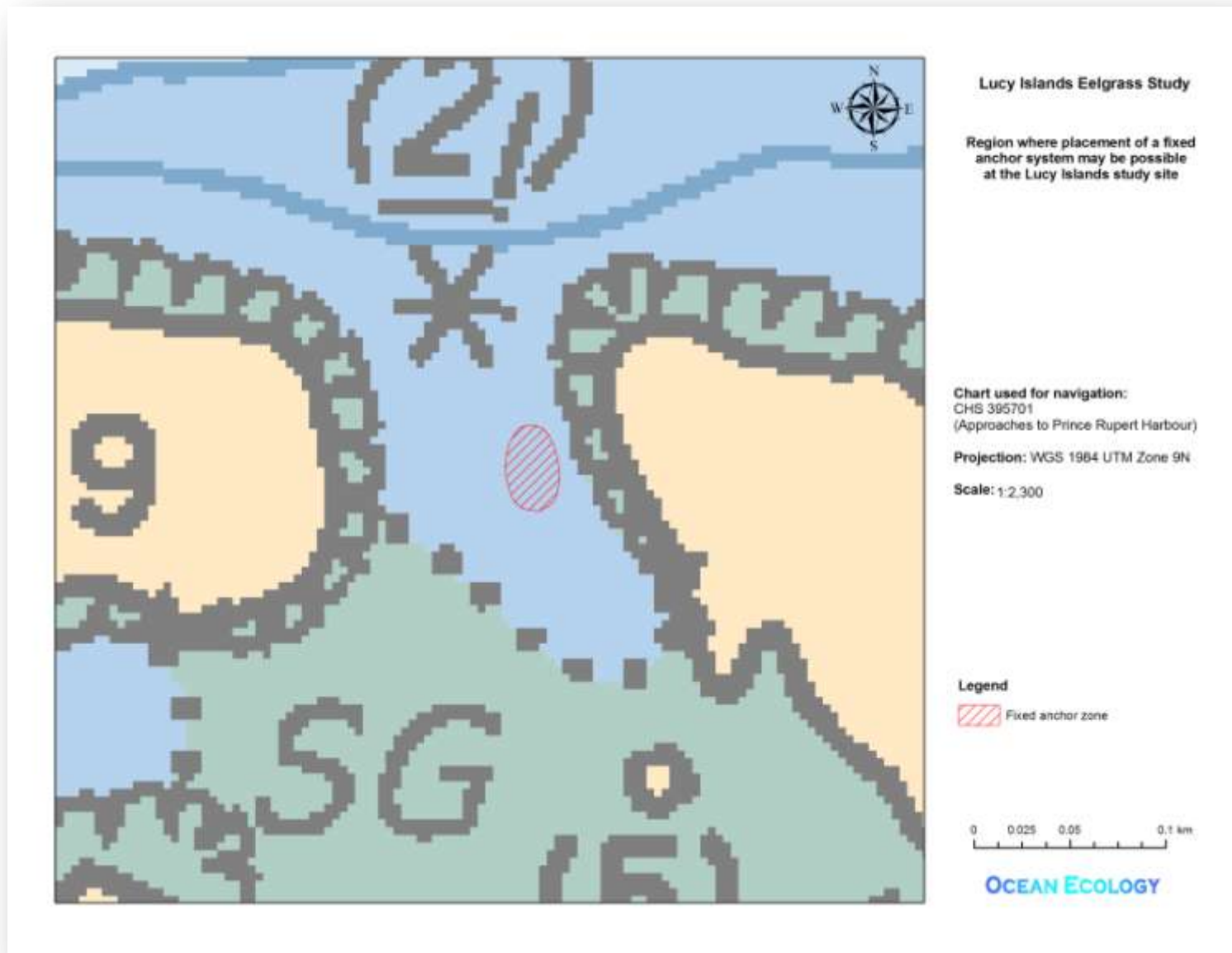

Figure 84. Region where placement of a fixed anchor system may be possible at the Lucy Islands study site.

Private organizations and government agencies will want to know how to minimize their potential exposure to legal liability (responsibility) for claims for damages arising from use of mooring buoys. While there is no solution that can protect an organization or a person from liability for irresponsible or unsafe actions, an organization can virtually eliminate its chances of unfairly being held responsible for injuries or property damage by using reasonable care and good judgment. Proper installation of mooring buoys and a well designed, implemented, and documented program of inspection and maintenance will go a long way toward establishing the use of “reasonable care” in mooring buoy projects (Project AWARE Foundation, 1996).

A person who undertakes to perform a task, even gratuitously, assumes a duty to act carefully in carrying it out. Consequently, when a party undertakes to supply buoys to the public, they are placed under a duty to act carefully. If they do not act as reasonably competent providers and maintainers of mooring buoys, they will be in breach of this duty. In this case, acting carefully includes such actions as (Project AWARE Foundation, 1996):

- Avoiding acts or omissions which can be reasonably foreseen to be likely to injure another by taking precautions. This involves consideration and balancing of three factors: (1) the likelihood of the risk materializing; (2) the potential severity of the damage should it occur; and (3) the practicality of the precautions.
- It may be necessary to give all potential mooring buoy users warnings of the steps necessary to ensure safe use of the buoys.
- Notices on mooring buoys excluding liability for all accidents howsoever caused may be effective under certain circumstances. Courts will closely scrutinize the disclaimer to determine whether it is fair and reasonable to allow reliance on it under the circumstances.
- Assigning assumption of risk - if a vessel owner has discretion over whether to use mooring buoys, it may be possible to assert later that the injured party “assumed the risk” of using the buoy, and therefore should be denied compensation for resultant injuries.

To prove that one has exercised reasonable care, it is necessary to (1) prove that the mooring buoys have been properly installed; (2) show that the moorings are properly inspected and maintained; and (3) provide warnings that are clear and detailed enough to allow boat owners and their users to use buoys in reasonable safety, or at minimum, be made aware of the extent and nature of the risk involved (Project AWARE Foundation, 1996).

## 4 Project Outcomes as Related to Project Objectives

**Objective 1:** To assess the productivity and ecological roles of eelgrass on the north coast. Eelgrass beds in northern B.C. are frequently smaller, deeper, and are found over a wider range of bottom types than eelgrass beds in southern B.C. Their ecological roles and their relationships to closely associated marsh grass habitats in northern B.C. are poorly understood.

Eelgrass in northern B.C. is subject to large tidal ranges, strong currents, and heavy winter storm activity. At the Lucy Islands study site, strong currents and storm waves produced seasonal sand migration, with the sand moving offshore to sand bars in the winter and back to the intertidal beach area in the summer. Eelgrass was less abundant and more prone to erosion and up-rooting in the center of the channel where current velocity and sand migration was the greatest. Thus, although healthy and abundant, the eelgrass at the Lucy Islands study site was patchy and discontinuous in its distribution, rather than forming a thick, homogenous seafloor cover as has been observed in some eelgrass beds in southern B.C. Additionally, eelgrass was most abundant at the site in areas of mixed pebble, cobble, and sand substrate. The presence of pebbles and cobbles probably reduced the sand migration, thus increasing substrate stability and preventing up-rooting and loss of eelgrass plants. This may explain why eelgrass in northern B.C. is found more commonly in mixed substrate than in southern B.C.

The eelgrass at the Lucy Islands study site occurred in both the subtidal and intertidal zones. In the subtidal regions, it appeared to be the *Zostera marina latifolia* ecotype, whereas in the lower intertidal zone, it was the *Z. marina phillipsi* ecotype, and in the upper intertidal zone, it was the *Z. marina typica* ecotype.

Eelgrass abundance and distribution was greatest in the summer. During the fall, in response to decreased light, both eelgrass and macroalgae growth at the site decreased. Heavy storm activity resulted in the erosion and removal of much of the flora biomass at the site. By April, in response to the increasing light, the macroalgae had already returned to nearly the same abundance and diversity as they had shown the previous summer. However, the eelgrass was still less abundant than it had been during the previous summer, as it does not reach its maximum biomass until August.

During the spring, summer, and fall surveys of the Lucy Islands study site, a total of 14 species of macroalgae, 49 species of marine fauna, and 17 species of birds were observed. Species richness was greatest in spring and summer, and least during the fall. Total marine species richness and species abundance was highest during the spring survey. This was paralleled by bird species richness, which was also highest in the spring. During the fall survey, juvenile salmon, most likely chinook, were present in schools at the site. Dungeness crabs were also present in both the summer and fall surveys.

There is a correlation between the seasonal cycles of both the marine flora and the marine fauna at the Lucy Islands study site. High species richness during the spring and summer was correlated with high eelgrass density. The eelgrass is clearly providing suitable niches for a number of organisms. Eelgrass beds probably function to stabilize the mobile sand substrate, thus providing areas where other organisms can become anchored, such as algae and sessile fauna. Mobile fauna find food and refuges from predators in the eelgrass blades. Birds are more common on the islands during the times when marine fauna are most abundant, and are probably feeding on these organisms.

While there was no marsh grass present at the Lucy Islands study site, an interesting relationship between eelgrass and surfgrass was observed. At the upper edge of the intertidal zone, as the eelgrass became less abundant, patches of surfgrass started to appear. In this transitional zone between eelgrass and surfgrass, differentiation between the two species became quite difficult as they were often intermixed.

**Objective 2:** *To compare the productivity of the Lucy Islands' eelgrass bed with other eelgrass beds, such as Flora Bank, in the Skeena River estuary region in order to better understand the relationships between global climate changes, changes in river flow and sedimentation patterns, and changes in eelgrass productivity.*

The Lucy Islands' eelgrass bed is located at the edge of the Skeena River influence during spring freshet. Thus, while it receives terrestrial nutrients from the river, particularly nitrogen, it does not experience the full impact of the plume turbidity. Since the water at the Lucy Islands is clear enough to transmit light down to the seafloor in some subtidal areas, eelgrass is found growing to depths of 2 - 3 m. This is in contrast to observations made of eelgrass growing at Flora Bank, which is located much closer to the mouth of the Skeena and is within the turbid region of the plume year round. Due to the high turbidity at Flora Bank, any eelgrass growing in the subtidal environment is likely to be severely light limited. Thus, the Flora Bank eelgrass bed was limited to only those regions where the depth was shallow enough to allow good light penetration, namely the intertidal zone. Very little subtidal eelgrass occurred at Flora Bank (Faggetter, 2009).

The presence of river-derived nutrients at the Lucy Islands allows lush eelgrass growth to occur. During the summer, the blades on the subtidal eelgrass were up to 2 m long. Eelgrass at Flora Bank, which was light-limited rather than nutrient-limited, had a maximum blade length of 0.45 m (Faggetter, 2009).

Although the effects of global climate changes on the Skeena River estuary are not yet fully understood, one possible effect is a change in timing of the maximum river flows. Global warming may lead to reduced snow packs as a result of increasing average temperatures, but may also increase the intensity of fall storms. Precipitation falling as heavy rain rather than snow has the potential to increase the volume of sediment entering the river. Increased riverine sediment may have significant impacts on eelgrass. Eelgrass beds closest to the mouth of the river may experience increased turbidity, which could lead to reduced growth. Additionally, some of the beds may not be able to grow fast enough to outpace the increased rate of sediment build-up. However, eelgrass beds at the edge of the Skeena plume may avoid this sedimentation effect, either partially or totally, and continue to function as healthy ecosystems. Mobile organisms, such as a juvenile fish, may end up using the "outer" eelgrass beds in preference to "inner" beds which have become silted over.

**Objective 3:** *To assess the damage caused to the Lucy Islands' eelgrass bed by the use of anchors during the course of recreational boater activities in the area. Possible solutions to this problem were evaluated.*

Side scan sonar images were taken of the seafloor at the Lucy Islands site. Side scan sonar produces images of the seafloor which appear similar to black-and-white photographs, and which can be used to identify bottom features. Examination of these images showed a few small pockmarks and linear scrapes which could have been the result of anchor damage; however, considering the amount of anthropogenic activities taking place at the site, including pile driving, there were relatively few signs of damage to the eelgrass bed. It seems likely that the seasonal migration of sand into and out of the site quickly removes any signs of damage.

Although evidence of anthropogenic damage to the eelgrass bed may be rapidly obliterated by moving sand at the Lucy Islands site, this does not mean that damage from anchoring and other human activities at the site are insignificant in the long term. Constant up-rooting of eelgrass plants will eventually decrease the productivity of the eelgrass bed, increase the mobility of the substrate, and create a habitat which is less rich and diverse than the one which presently exists at the site. Since the site is located at the trailhead of the Lucy Islands trail, which will encourage anchoring at the site, it is recommended that some type of fixed anchor system be put in place at the site. Two potential systems have been recommended: (1) a helical screw anchor system; and (2) a steel piling with a float collar. The helical screw anchor system is the preferred choice, since it is less disrupting to the eelgrass to install, costs less to put in at the site, and has been used successfully in other eelgrass environments (JCMRC Eelgrass Protection Work Group, 2010).



However, the placement of helical screw anchors requires some degree of expertise, and the anchors themselves are not readily available in Prince Rupert. For these reasons, the piling solution was suggested as an alternative, as both the knowledge and materials for this type of deployment are available in Prince Rupert.

Based on the surveys of the Lucy Islands eelgrass bed, an area has been selected where the placement of a fixed anchor system will provide the best compromise between preventing damage to the eelgrass bed and providing a safe anchorage to users of the site which is accessible to the trailhead.

**Objective 4:** *To provide a clearer understanding of the ecological relationship of the Lucy Islands' eelgrass bed to the Lucy Islands' role as an established IBA for rhinoceros auklets, pigeon guillemots, glaucous winged gulls, and black oystercatchers.*

More species of birds were present, and the overall number of individual birds was higher, when the eelgrass was most abundant. Some birds, such as pigeon guillemots, glaucous winged gulls, and black oystercatchers, were clearly feeding at the site. Rhinoceros auklets were observed feeding offshore; however, evidence of their presence on the islands was observed. A likely hypothesis is that when eelgrass is abundant, it provides both a source of food and a protective habitat for many species of marine fauna. These organisms, in turn, serve as prey items for marine birds. This may be of particular importance to nesting birds whose foraging range may be reduced by the requirements to incubate eggs and guard the nest and hatchlings. As an example, pigeon guillemots were observed feeding in the waters at the Lucy Islands directly below their nesting ledges. In fact, these nesting sites may well have been chosen by the birds due to their close proximity to good feeding areas.

**Objective 5:** *To assess the use of side scan sonar as a tool to quantify subtidal eelgrass beds.*

Although still a developing technology, the use of side scan sonar to delimit the extent of eelgrass beds is not in and of itself a novel technique. However, the experimental equipment deployed by Ocean Ecology is unique in several ways:

- The Humminbird 997c SI side scan unit is a commercially available recreational unit which sells for approximately \$2000 as compared to the \$20,000 or more for most side scan units used for scientific research. A simple towfish can be constructed for under \$200 which allows the Humminbird unit to be used in a number of applications.
- Ocean Ecology has written software which converts the Humminbird proprietary data format into a form which can be read by an open source side scan image processing software. This further reduces the costs of setting up a side scan system, as much of the commercial side scan mosaicing software is in excess of \$5000 to purchase.
- Ocean Ecology has also designed some experimental software which uses data from the downward-looking sonar of the Humminbird 997c SI unit to measure the height of the eelgrass. This may be useful in quantifying as well as delimiting eelgrass beds using side scan sonar.

The image quality of the side scan data produced by the Humminbird 997c SI unit was comparable with that of images produced by more expensive systems (Bailey, *et al.*, 2007; Woodruff *et al.*, 2006). In light of the significant difference in set-up costs between the Humminbird system and other systems used in scientific research, this is a very significant outcome. It may make it possible for small organizations with limited funding to be able to collect high quality side scan data.

Two side scan processing techniques were used to assist in the identification and measurement of eelgrass areal coverage in side scan images: (1) texture analysis using grey level co-occurrence matrices (GLCM); and (2) false coloring of back scatter intensity. GLCM analysis was effective at identifying eelgrass clumps, and gave reasonable results for spatial coverage, but did not provide any information regarding the density of the eelgrass within the clumps. Back scatter intensity analysis provided information on both spatial coverage and density, and thus had better correlation with the towed video data analysis. However, back scatter intensity was adversely affected by the presence of boulders and steep beach faces, and was unable to accurately differentiate eelgrass in these situations. Both GLCM and back scatter analysis have significant potential usefulness for future eelgrass surveys, but will need a bit more “fine-tuning”.

Measurement of eelgrass height using the downward-looking sonar was very successful, with good correlation between measured eelgrass height and eelgrass population density as observed by the towed video analysis. While this technique does not differentiate between eelgrass and macroalgae, once an eelgrass bed has been located, this method could be used to track changes in eelgrass height, and thus productivity, throughout the year or over the course of several years.

Draft

## 5 Project Deliverables

In addition to this report, the following materials have also been provided from the subtidal survey:

1. Three DVDs containing raw georeferenced seabed video imagery\* (overlaid with time, latitude, and longitude) of the survey site.
2. Two DVDs containing:
  - a. java-based software which links video\* and GPS data, allowing simultaneous viewing of the camera's geographical position on a map and the video images captured by the camera at that location.
  - b. a library of video\* annotations
3. One DVD containing:
  - a. a georeferenced, classified Access database\* for biological and physical features of the seabed.
  - b. an electronic ArcGIS project\* containing maps of analyzed video data.
  - c. a report describing and explaining the results of the video survey.
  - d. a library of reference material used in the report
  - e. video data from the North Coast 2000 Aerial Video Imaging Survey showing the Lucy Islands

\*Note: time on the video imagery, in the database, and in the ArcGIS project is given in PST (Pacific Standard Time).

## 6 References Cited

- Bailey, A., Norris, J., Fraser, I., Petrillo, T. 2007. Snohomish County, Washington County-Wide Eelgrass Inventory. Snohomish County Surface Water Management Marine Resources Committee.
- Beamish, R.J., Pearsall, I.A., Healey, M.C. 2003. A History of the Research on the Early Marine Life of Pacific Salmon Off Canada's Pacific Coast. NPAFC Bulletin No. 3.
- Blondel, Ph., Parson, L.M., Robigou, V. 1998. TexAn: Textural Analysis of Side scan Sonar Imagery and Generic Seafloor Characterization. IEEE Oceans 98 Conference.
- Brekhovskikh, L. and Lysanov, Y. 1982. Fundamentals of ocean acoustics. Ed. L. Felsen. Springer Series in Electrophysics Volume 8. Springer-Verlag, Berlin.
- Cameron, W.M. 1948. Fresh Water in Chatham Sound. Fish Resources Bd. Pac. Prog. Report 76:72-75.
- Causey, B., Quirolo, C., Merrill, D., De Meyer, K., Jacobson, A., Rowat, D. 2005. Mooring Buoys as a Management Tool for Controlling Visitor Impacts: An Introduction. MPA News: International News and Analysis on Marine Protected Areas. Vol. 7, No. 3.
- Coastal & Ocean Resources Inc. (CORI). 2000. North Coast 2000 Aerial Video Imaging Survey.
- DFO. 2009. Does Eelgrass (*Zostera marina*) Meet the Criteria as an Ecologically Significant Species? DFO Can. Sci. Advis. Sec. Sci. Advis. Rep. 2009/018.
- Druehl, L.D., Cabot, E.L. 1987. Seasonal growth of *Laminaria groenlandica* as a function of plant age. Can. J. Bot. 65: 1599-1604.
- Faggetter, B.A. 2009. Flora Bank Eelgrass Survey. Prepared for WWF.
- Faggetter, B.A. 2010a. Side scan and Multibeam Processing Using Cygwin on Windows XPPro. [http://www.oceanecology.ca/Software/Side\\_scan-multibeam\\_processing\\_in\\_cygwin.htm](http://www.oceanecology.ca/Software/Side_scan-multibeam_processing_in_cygwin.htm).
- Faggetter, B.A. 2010b. Processing Humminbird Side scan Data Using USGS MIPS. [http://www.oceanecology.ca/Software/Processing\\_Humminbird\\_Side\\_scan\\_Data\\_Using\\_USGS\\_MIPS.htm](http://www.oceanecology.ca/Software/Processing_Humminbird_Side_scan_Data_Using_USGS_MIPS.htm).
- Faggetter, B.A. 2010c. Processing Humminbird Side scan Data Using MB-System. [http://www.oceanecology.ca/Software/Processing\\_Humminbird\\_Side\\_scan\\_Data\\_Using\\_MB-System.htm](http://www.oceanecology.ca/Software/Processing_Humminbird_Side_scan_Data_Using_MB-System.htm).
- Faggetter, B.A. 2010d. Processing Humminbird Side scan Backscatter Data. [http://www.oceanecology.ca/Software/Processing\\_Humminbird\\_Side\\_scan\\_Backscatter\\_Data.htm](http://www.oceanecology.ca/Software/Processing_Humminbird_Side_scan_Backscatter_Data.htm).
- Faggetter, B.A. 2010e. Processing Humminbird Multibeam Data Using MB-System. [http://www.oceanecology.ca/Software/Processing\\_Humminbird\\_Multibeam\\_Data\\_Using\\_MB-System.htm](http://www.oceanecology.ca/Software/Processing_Humminbird_Multibeam_Data_Using_MB-System.htm).
- Francour P., Magréau J.F., Mannoni P.A., Cottalorda J.M., Gratiot J. 2006. Management guide for Marine Protected Areas of the Mediterranean Sea, Permanent Ecological Moorings. Université de Nice-Sophia Antipolis & Parc National de Port-Cros, Nice : 68 pp.
- G3 Consulting Ltd. 2003. Guidebook: Environmentally Sustainable Log Handling Facilities in British Columbia. Report prepared for Fisheries and Oceans Canada, Pacific and Yukon Region, Habitat and Enhancement Branch by G3 Consulting Ltd., Burnaby BC. 72 pp. + appendices.
- Hahn, P.K.J., Bailey, R.E., Ritchie, A. Beach Seining. 2008. In Salmonid Field Protocols Handbook: Techniques for assessing status and trends in salmon and trout populations. American Fisheries Society. pg. 267-324. <http://www.stateofthesalmon.org/fieldprotocols/>

- Harrison, P.J., Clifford, P.J., Cochlan, W.P., Yin, K., St. John, M.A., Thompson, P.A., Sibbald, M.J., Albright, L.J. 1991. Nutrient and plankton dynamics in the Fraser River plume, Strait of Georgia, British Columbia. *Mar. Ecol. Prog. Ser.* 70: 291-304. <http://www.int-res.com/articles/meps/70/m070p291.pdf>.
- IBA Canada. 2011. Important Bird Areas in Canada. Lucy Islands IBA Site Summary. <http://www.ibacanada.ca/>.
- JCMRC Eelgrass Protection Work Group. 2010. Voluntary No-Anchor Eelgrass Protection Zone: A Non-Regulatory Marine Protected Area. Port Townsend Bay, Washington. Summary Report 2010.
- Kendall, M., McNeil, L., Needham, H. 2005. Yacht Moorings and Benthic Biodiversity. Plymouth Marine Laboratory.
- McGee, P. 1998. Kayak routes of the Pacific Northwest coast. Greystone Books, Vancouver, B.C.
- Ministry of Environment. 2008. New Parks and Conservancies for B.C. Protected Areas of British Columbia (Conservancies and Parks) Amendment Act, 2008.
- Ministry of Sustainable Resource Management Land and Resource Data Warehouse. 2011. Coastal Resource Information System. [http://webmaps.gov.bc.ca/imf5/imf.jsp?site=dss\\_coastal](http://webmaps.gov.bc.ca/imf5/imf.jsp?site=dss_coastal).
- Park Notes. 2004. Port Philip and Western Port Public Swing Moorings. Parks Victoria.
- Pedersen, M.F., Borum, J. 1993. An annual nitrogen budget for a seagrass *Zostera marina* population. *Mar. Ecol. Prog. Ser.* 101: 169-177.
- Penrose, J.D., Siwabessy, P.J.W., Gavrilov, A., Parnum, I., Hamilton, L.J., Bickers, A., Brooke, B Ryan, D.A., Kennedy, P. 2005. Acoustic Techniques for Seabed Classification. Cooperative Research Centre for Coastal Zone Estuary and Waterway Management, Technical Report 32.
- Pojar, J. 2002. Rare Ecosystems of the CWHvh2. <http://www.citbc.org/b-RareEcos-Pojar-Feb02.pdf>.
- Precision Identification Biological Consultants. 2002. Field Methods for Mapping and Monitoring Eelgrass Habitat in British Columbia. Environment Canada.
- Project AWARE Foundation. 1996. Mooring Buoy Planning Guide. International PADI, Inc. Rancho Santa Margarita, CA.
- Rabnett, K. 2006. Lower Skeena Fish Passage Assessment Highway #16, #37S, and CN Rail. Skeena Fisheries Commission.
- Sluys, W.W. 1982. Floating moorage device for use with piles or dolphins. United States Patent 4,357,891.
- Stoffels, D. 2002. Review of Public Use in the North Coast LRMP Area. Ministry of Forests, North Coast Forest District. [http://archive.ilmb.gov.bc.ca/slrp/lrmp/nanaimo/ncoast/docs/reports/technical/Public\\_Use\\_info\\_Jan2002.pdf](http://archive.ilmb.gov.bc.ca/slrp/lrmp/nanaimo/ncoast/docs/reports/technical/Public_Use_info_Jan2002.pdf).
- Stone, R.P., O'Clair, C.E. 2001. Seasonal movements and distribution of Dungeness crabs *Cancer magister* in a glacial southeastern Alaska estuary. *Mar. Ecol. Prog. Ser.* 214: 167-176.
- Stronach, J. and Zaremba, L. 2002. Wave and current forecast system for the mouth of the Fraser River. Hay and Company Consultants. <ftp://ftp.wmo.int/Documents/PublicWeb/amp/mmop/documents/JCOMM-TR/J-TR-34-9th-waves-workshop/Papers/Stronach.pdf>.
- Thom, R.M. 1984. Composition, Habitats, Seasonal Changes and Productivity of Macroalgae in Grays Harbor Estuary, Washington. *Estuaries* 7: 51-60.

Trites, R.W. 1956. The Oceanography of Chatham Sound, British Columbia. J. Fish Res. Bd. Canada 13(3):385-434.

Vermeer, K. 1979. Nesting requirements, food and breeding distribution of rhinoceros auklets, *Cerorhinca monocerata*, and tufted puffins, *Lunda cirrhata*. Ardea 67: 101-110.

Woodruff, D. L., Kohn, N.P., Borde, A. B., Evans, N. R., Southard, J. A., Thom, R.M. 2006. First Annual Report: 2004 Pre-Construction Eelgrass Monitoring and Propagation for King County Outfall Mitigation. Marine Sciences Laboratory.

Wright, N. 2004. The BC Coastal Eelgrass Stewardship Project. 2002-2004 Report. Seagrass Conservation Working Group

Draft

## 7 Appendix

Table 10. Substrate type codes.

Substrate Composition	Class	Subclass	Description
Rock (R)			Bedrock outcrop; may be partially covered with a veneer of sediment.
Veneer over bedrock (vR)			Intermittently visible bedrock covered with a thin veneer of clastic sediments.
Clastic (C)			Seabed comprised of mineral grains of gravel-, sand- or mud-sized material.
	Gravel (G)	Boulder (B)	Percentage boulder (>25.6 cm in size) on seabed.
		Cobble (CO)	Percentage cobble (6.4 to 25.6 cm in size) on seabed.
		Pebble (P)	Percentage pebble (4 mm to 6.4 cm in size) on seabed.
		Granules (GR)	Percentage granules (2-4 mm in size) on seabed.
	Sand (S)	Sand (S)	Percentage sand (0.062 to 2 mm in size) on seabed.
	Silt-mud (M)	Silt-mud (M)	Percentage silt-mud (<0.62 mm in size) on seabed.
Biogenic (B)			Surface of seabed comprised of material of biogenic origin, such as vegetation.
	Organics (O)	Shell (SH)	Percentage coarse (> 2 mm in size) shell debris on seabed.
		Organic debris (OD)	Percentage organic debris on seabed.
		Wood debris (WD)	Percentage wood debris on seabed.
Anthropogenic (A)			Features of man-made origin, such as trawl marks, anchor drag marks, or cable drag marks.

Table 11. Average particle size values.

Substrate Class/Subclass	Average Size (mm)
Rock	10000
Veneer over bedrock	10000
Boulder	512
Cobble	256
Pebble	64
Granules	4
Sand	2
Silt-mud	0.62
Shell	--
Organic debris	--
Wood debris	--
Anthropogenic	--

Table 12. Percentage substrate cover codes.

Class Code	Percentage Cover
1	T-5%
2	5-30%
3	30-50%
4	50-80%
5	>80%

Table 13. Average percentage substrate cover values.

Percentage Substrate Cover Class Code	Average Percentage Cover Value
1	2.5%
2	17.5%
3	40%
4	65%
5	90%



Table 14. Vegetation codes.

Algal Class	Subclass	Code	Description
Green Algae (GRA)	Foliose greens	FOG	Primarily <i>Ulva</i> , but also including <i>Enteromorpha</i> and <i>Monostroma</i> .
	Filamentous greens	FIG	The various filamentous green/red assemblages ( <i>Spongomorpha/Cladophora</i> types).
Brown Algae (BA)	Fucus	FUC	<i>Fucus</i> and <i>Pelvetiopsis</i> species groups.
	Sargassum	SAR	<i>Sargassum</i> is the dominant and primary algal species.
	Nemalion	NEM	Filamentous <i>Nemalion</i> sp. is the dominant species.
	Soft brown kelps	BKS	Large laminarian bladed kelps, including <i>L. saccharina</i> and <i>groenlandica</i> , <i>Costaria costata</i> , <i>Cymathere triplicata</i> .
	Seersucker kelp	SEE	<i>Costaria costata</i> .
	Split kelp	SPL	<i>Laminaria setchellii</i> .
	Sugar wrack kelp	SWK	<i>Laminaria saccharina</i> .
	Suction-cup kelp	SUC	<i>Laminaria yezoensis</i> .
	Dark brown kelps	BKD	The LUCO chocolate brown group, <i>L. setchellii</i> , <i>Pterygophora</i> , <i>Lessoniopsis</i> . <i>Alaria</i> and <i>Egregia</i> may also be present. Generally more exposed than soft browns.
	Alaria	ALA	<i>Alaria</i> sp.
	Agarum	AGR	<i>Agarum</i> is the dominant species, but other laminarians may also occur. Generally found deeper than Laminarian subgroup.
	Fringed sea colander kelp	FSC	<i>Agarum fimbriatum</i> .
	Three-ribbed kelp	TRK	<i>Cymathere triplicata</i> .
	Stringy acid weed	STW	<i>Desmarestia viridis</i> .
	Broad acid weed	BRW	<i>Desmarestia lingulata</i> .
	Macrocystis	MAC	Beds of canopy forming giant kelp.
	Nereocystis	NER	Beds of canopy forming bull kelp.

Algal Class	Subclass	Code	Description
Red Algae (RED)	Foliose reds	FOR	A diverse species mix of foliose red algae ( <i>Gigartina</i> , <i>Iridea</i> , <i>Rhodomyenia</i> , <i>Constantinia</i> ) which may be found from the lower intertidal to depths of 10 m primarily on rocky substrate.
	Filamentous reds	FIR1	A diverse species mix of filamentous red algae (including <i>Gastroclonium</i> , <i>Odonthalia</i> , <i>Prionitis</i> ) which may be found from the lower intertidal to depths of 10 m, often co-occurring with the foliose red group described above.
	Filamentous reds	FIR2	A mix of red algae (primarily <i>Neoagardhiella</i> and <i>Gracilaria</i> ) which grow on "submerged" cobble and pebble in fine sand and silt bottoms.
	Coralline reds	COR	Rocky areas with growths of encrusting and foliose forms of coralline algae.
	Halosaccion	HAL	<i>Halosaccion glandiforme</i> .
	Red fringe	RFR	<i>Smithora.naiadum</i>
Seagrasses (SGR)	Eelgrass	ZOS	Eelgrass beds.
	Surfgrass	PHY	Areas of surfgrasses ( <i>Phyllospadix</i> ), which may co-occur with subgroup BKS or BKD above.
No Vegetation		NOV	No vegetation observed.
Cannot Classify		X	Vegetation present but cannot be identified. Imagery is not clear, classification not possible.

Table 15. Vegetation coverage codes.

Code	Class	Abundance
1	Sparse	Less than 5% cover.
2	Low	5 to 25% cover.
3	Moderate	26 to 75% cover.
4	Dense	>75% cover.

Table 16. Average percentage vegetation cover values.

Percentage Vegetation Cover Class Code	Average Percentage Cover Value
1	2.5%
2	15%
3	50%
4	87.5%

Table 17. Fauna codes.

Species or Species Complex	Code	Description
Bacterial mat	BCM	Unidentified bacterial mat; sulfuretum.
Sponges	USP	Unidentified sponge.
	CLD	Cloud sponge ( <i>Aphrocallistes vastus</i> ).
	SBS	Sharp lipped boot sponge ( <i>Rhabdocalyptus dawsoni</i> ).
	RSB	Round lipped boot sponge ( <i>Staurocalyptus dowlingi</i> ).
	SVS	Stalked vase sponge ( <i>Leucilla nuttingi</i> ).
	BRS	Breast sponge ( <i>Eumastia sitiens</i> ).
Jellyfish	MJF	Moon jellyfish ( <i>Aurelia labiata</i> ).
	CYC	Lion's mane jellyfish ( <i>Cyanea capillata</i> ).
Hydroids	HYD	Unidentified hydroids.
	HYM	Hydromedusa sp.
Anemones	PAF	Tube-dwelling anemone ( <i>Pachycerianthes fimbriatus</i> ).
	MET	Plumose anemone ( <i>Metridium</i> sp.).
	URT	Sea anemone ( <i>Urticina</i> sp.).
	XAN	Giant green anemone ( <i>Anthopleura xanthogrammica</i> ).
	CRI	Snake lock anemone ( <i>Cribrinopsis</i> sp.).
	ANT	Sea anemone ( <i>Anthopleura</i> sp.).
	STR	Strawberry anemone ( <i>Corynactis californica</i> ).
Corals/Hydrocorals	SPO	Orange sea pen ( <i>Ptilosarcus gurneyi</i> ).
	SPW	White sea pen ( <i>Virgularia</i> sp.).
	CUP	Orange cup coral ( <i>Balanophyllia elegans</i> ).
	SWP	Sea whip ( <i>Balticina septentrionalis</i> ).
	STY	Pink hydrocoral ( <i>Stylaster</i> sp.).
Worms	TUB	Parchment tube dwelling polychaete worms.
	TUC	Calcareous tube dwelling polychaete worms.
	LUG	Pacific lugworm ( <i>Abarenicola pacifica</i> ).

Species or Species Complex	Code	Description
Crabs	CRB	Unidentified crab.
	CAN	<i>Cancer</i> sp.
	DUN	Dungeness crab ( <i>Cancer magister</i> ).
	TAN	Tanner crab ( <i>Chionoecetes</i> sp.).
	KCR	Kelp crab ( <i>Pugettia</i> sp.).
	BXC	Box crab ( <i>Lopholithodes foraminatus</i> ).
	BXC	Box crab ( <i>Lopholithodes foraminatus</i> ).
	HEC	Helmet crab ( <i>Telmessus cheiragonus</i> ).
	SQT	Squat lobster ( <i>Munida quadraspina</i> ).
Shrimps (Pandalid)	PAN	Unidentified pandalid.
	PRN	Spot prawn ( <i>Pandalus platyceros</i> ).
	PNB	Spiny pink shrimp ( <i>Pandalus borealis</i> ).
	PNH	Humpback shrimp ( <i>Pandalus hypsinotus</i> ).
Ghost and mud shrimps	GHS	Ghost shrimp ( <i>Callinassa californiensis</i> ).
	MDS	Mud shrimp ( <i>Upogebia pugettensis</i> ).
Gastropods	WHK	Unidentified whelk.
	ELI	Eelgrass limpet ( <i>Lottia alveus paralella</i> ).
	NUC	Dogwinkle ( <i>Nucella</i> sp.).
	CDV	Carinate dovesnail ( <i>Alia carinata</i> ).
	TBI	Threaded bittium ( <i>Bittium eschrichtii</i> ).
	MOO	Moon snail ( <i>Euspira lewisii</i> ).
	WLN	White-lined nudibranch ( <i>Dirona albolineata</i> ).
	TOT	Orange-peel nudibranch ( <i>Tochuina tetraquetra</i> ).
	Bivalves	MUS
GCL		Geoduck clam ( <i>Panopea abrupta</i> ).
HCL		Horseclam ( <i>Tresus</i> sp.).
PCL		Piddock clam.
BCL		Butter clam ( <i>Saxidomas gigantea</i> ).
COC		Nuttall's cockle ( <i>Clinocardium nuttallii</i> ).
SFC		Softshell clam ( <i>Mya</i> sp.).
OYS		Oyster.
OCL		Other clam species.
SCA		Scallop ( <i>Chlamys</i> sp.)
TER	Teredo worm ( <i>Bankia setacea</i> ).	
Octopus	OCT	Pacific octopus ( <i>Octopus</i> ).
Bryozoan Complex	BRY	Bryozoans, ascidians, sponges - generally on rock substrate.
Brachiopods	BRA	Unidentified brachiopod.
	LAM	California lamp shell ( <i>Laqueus californicus</i> ).





Species or Species Complex	Code	Description
Seastars	BRE	Short-spined seastar ( <i>Pisaster brevispinus</i> ).
	EVA	False ochre seastar ( <i>Evasterias troschelli</i> ).
	PYC	Sunflower seastar ( <i>Pycnopodia helianthoides</i> ).
	POR	Ochre seastar ( <i>Pisaster ochraceus</i> ).
	DER	Leather star ( <i>Dermasterias imbricata</i> ).
	GEP	Gunpowder star ( <i>Gephyreaster swifti</i> ).
	WRS	Wrinkled star ( <i>Pteraster militaris</i> ).
	PTT	Slime star ( <i>Pteraster tesselatus</i> ).
	VER	Vermilion star ( <i>Mediaster aequalis</i> ).
	HEN	Seastar ( <i>Henricia</i> sp.).
	SOL	Seastar ( <i>Solaster</i> sp.).
	COO	Cookie star ( <i>Ceremaster patagonius</i> ).
	PLS	Pale star ( <i>Leptychaster pacificus</i> ).
	SMS	Spiny mudstar ( <i>Luidia foliolata</i> ).
	ORT	Painted star ( <i>Orthasterias koehleri</i> ).
	STF	Long ray star ( <i>Stylasteria forreri</i> ).
	SIX	Six-armed star ( <i>Leptasterias</i> sp.).
	ROS	Rose star ( <i>Crossaster papposus</i> ).
	STR	Unidentified seastar.
	Brittle Stars	BRT
GYB		Gray brittle star ( <i>Ophiura lütkeni</i> ).
Basket Stars	BSK	Basket star ( <i>Gorgonocephalus</i> sp.).
Feather Stars	FST	Feather star ( <i>Florometra serratissima</i> ).
Sand Dollars	SDD	Sand dollar ( <i>Dendraster excentricus</i> ).
Sea Urchins	RSU	Red sea urchin ( <i>Strongylocentrotus franciscanus</i> ).
	GSU	Green sea urchin ( <i>Strongylocentrotus droebachiensis</i> ).
	WSU	White sea urchin ( <i>Strongylocentrotus pallidus</i> ).
	PSU	Purple sea urchin ( <i>Strongylocentrotus purpuratus</i> ).
Sea Cucumbers	RCU	Rea sea cucumber ( <i>Cucumaria miniata</i> ).
	WCU	White sea cucumber ( <i>Psolus squamatus</i> ).
	PAR	California sea cucumber ( <i>Parastichopus californicus</i> ).
	ASC	Aggregating sea cucumber ( <i>Pseudocnus</i> sp.).
Tunicates	TUN	Unidentified tunicate.
	CIO	Tunicate ( <i>Ciona</i> sp.).
	PEA	Pacific sea peach ( <i>Halocynthia aurantium</i> )
In fauna "holes"	HLM	Mounded worm, clam or crustacean hole, but species or species group cannot be distinguished.
	HLF	Unmounded (flat) worm or clam hole, but species or species group cannot be distinguished.

Species or Species Complex	Code	Description
Fish	FSH	Unidentified fish.
	SAL	Unidentified salmonid.
	ELP	Unidentified eelpout (Zoarcidae).
	POA	Unidentified poacher.
	TUS	Tubesnout ( <i>Aulorhynchus flavidus</i> ).
	GBE	Black-eyed goby ( <i>Coryphopterus nicholsi</i> ).
	PLP	Pile perch ( <i>Rhacochilus vacca</i> ).
	PST	Striped perch ( <i>Embiotica lateralis</i> ).
	SHP	Shiner perch ( <i>Cymatogaster aggregata</i> ).
	FTF	Unidentified flatfish.
	STF	Starry flounder ( <i>Platichthys stellatus</i> ).
	RFS	Unidentified rockfish.
	BRF	Black rockfish ( <i>Sebastes melanops</i> ).
	NRK	China rockfish ( <i>Sebastes nebulosus</i> ).
	CRK	Copper rockfish ( <i>Sebastes caurinus</i> ).
	QRF	Quillback rockfish ( <i>Sebastes maliger</i> ).
	TRF	Tiger rockfish ( <i>Sebastes nigrocinctus</i> ).
	YRF	Yelloweye rockfish ( <i>Sebastes ruberrimus</i> ).
	GLG	Unidentified greenling (Hexagrammid).
	KGR	Kelp greenling ( <i>Hexagrammos decagrammus</i> ).
	LNG	Lingcod ( <i>Ophiodon elongatus</i> ).
	SCU	Unidentified sculpin (Cottidae).
	NRN	Northern ronquil ( <i>Ronquilus jordani</i> ).
	RAT	Ratfish ( <i>Hydrolagus collie</i> ).
	LSK	Longnose skate ( <i>Raja rhina</i> )
Unknown	UNK	Macro fauna visible but cannot be identified.
<b>No Fauna</b>	<b>NOF</b>	No fauna observed.

Table 18. Faunal distribution classes.

Code	Descriptor	Distribution
1	Few	Rare (single) or a few sporadic individuals.
2	Patchy	A single patch, several individuals or a few patches.
3	Uniform	Continuous uniform occurrence.
4	Continuous	Continuous occurrence with a few gaps.
5	Dense	Continuous dense occurrence.
6		Code specific for school of fish.

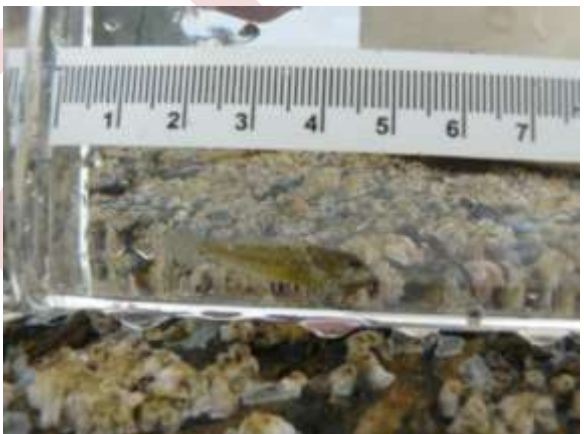
Table 19. Photographs of organisms caught during beach seining.

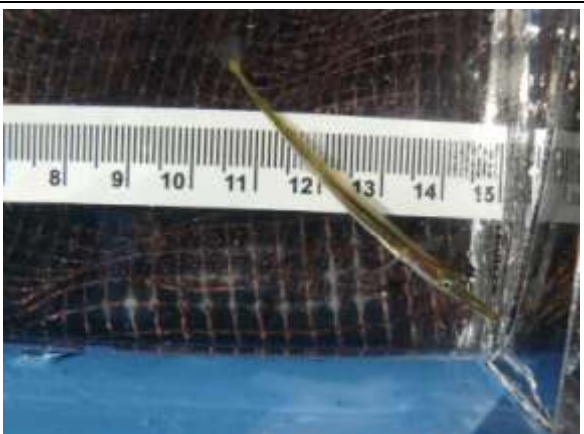
Species Photographs	
 <p>Crescent gunnel (<i>Pholis laeta</i>)</p>	 <p>Penpoint gunnel (<i>Apodichthys flavidus</i>)</p>
 <p>Buffalo sculpin (<i>Enophrys bison</i>)</p>	 <p>Fluffy sculpin (<i>Oligocottus snyderi</i>)</p>
 <p>Tidepool sculpin (<i>Oligocottus maculosus</i>)</p>	 <p>Tube-snout (<i>Aulorhynchus flavidus</i>)</p>

Species Photographs

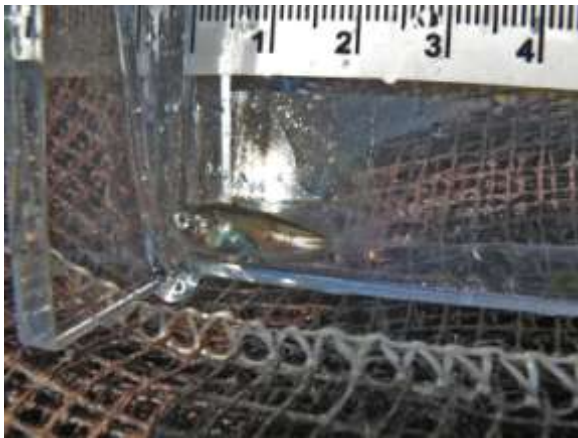

Pacific sandfish (*Trichodon trichodon*)

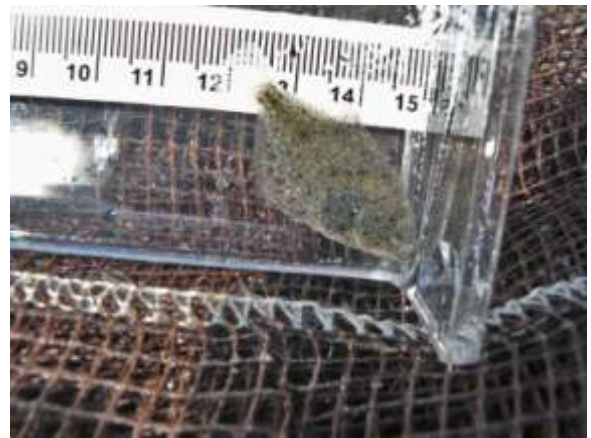

Sand sole (*Psettichthys melanostictus*)



Eelgrass isopod (*Idotea resecata*)

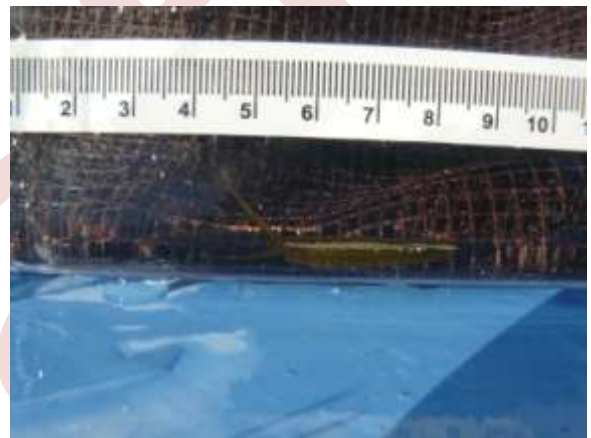

Feather boa isopod (*Idotea stenops*)

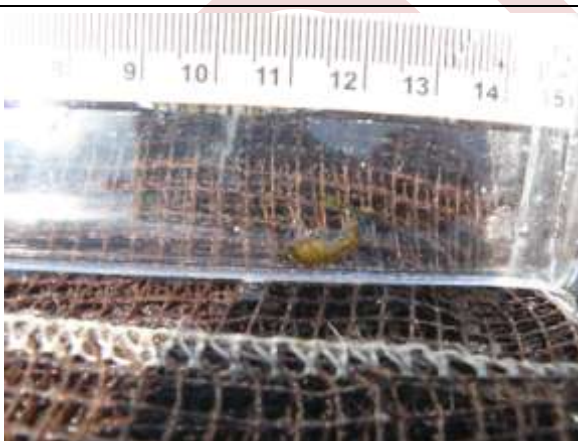

Pale beach hopper (*Megalorchestia columbiana*)

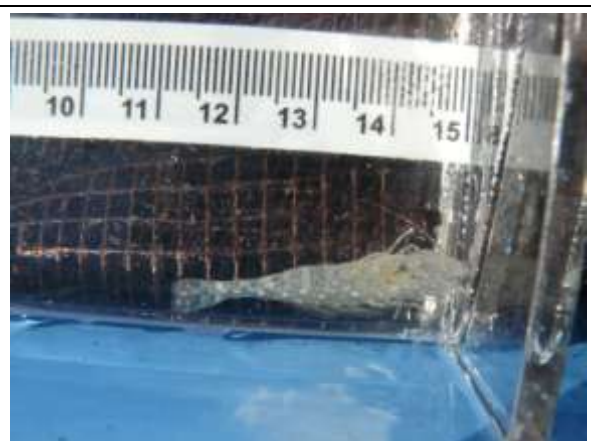

Blacktail shrimp (*Crangon nigricauda*)



Species Photographs



Small-eyed shrimp (*Heptacarpus carinatus*)



Stout shrimp (*Heptacarpus brevirostris*)



Threespine shrimp (*Heptacarpus tridens*)



Graceful kelp crab (*Pugettia gracilis*)

## 8 Disclaimer

The findings presented in this report are based upon data collected during the periods July 17<sup>th</sup> - July 19<sup>th</sup>, 2010, October 27<sup>th</sup>, 2010, and April 20<sup>th</sup>, 2011 using the methodology described in the Survey Methodology section of this report. Ocean Ecology has exercised reasonable skill, care, and diligence to collect and interpret the data, but makes no guarantees or warranties as to the accuracy or completeness of this data.

This report has been prepared solely for the use of the World Wildlife Fund, pursuant to the agreement between Ocean Ecology and World Wildlife Fund. Any use which other parties make of this report, or any reliance on or decisions made based on it, are the responsibility of such parties. Ocean Ecology accepts no responsibility for damages, if any, suffered by other parties as a result of decisions made or actions based on this report.

Any questions concerning the information or its interpretation should be directed to the undersigned.

Prepared By:



Barb Faggetter, Ph.D  
Oceanographer, R.P.Bio.

Reviewed By:

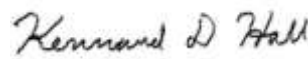

Kennard Hall, Captain  
Partner, Ocean Ecology

